



effe

PERFECT WELLNESS



BODYLOVE SH
LEGNO TRATTATO SCURO
VETRO A CANNE

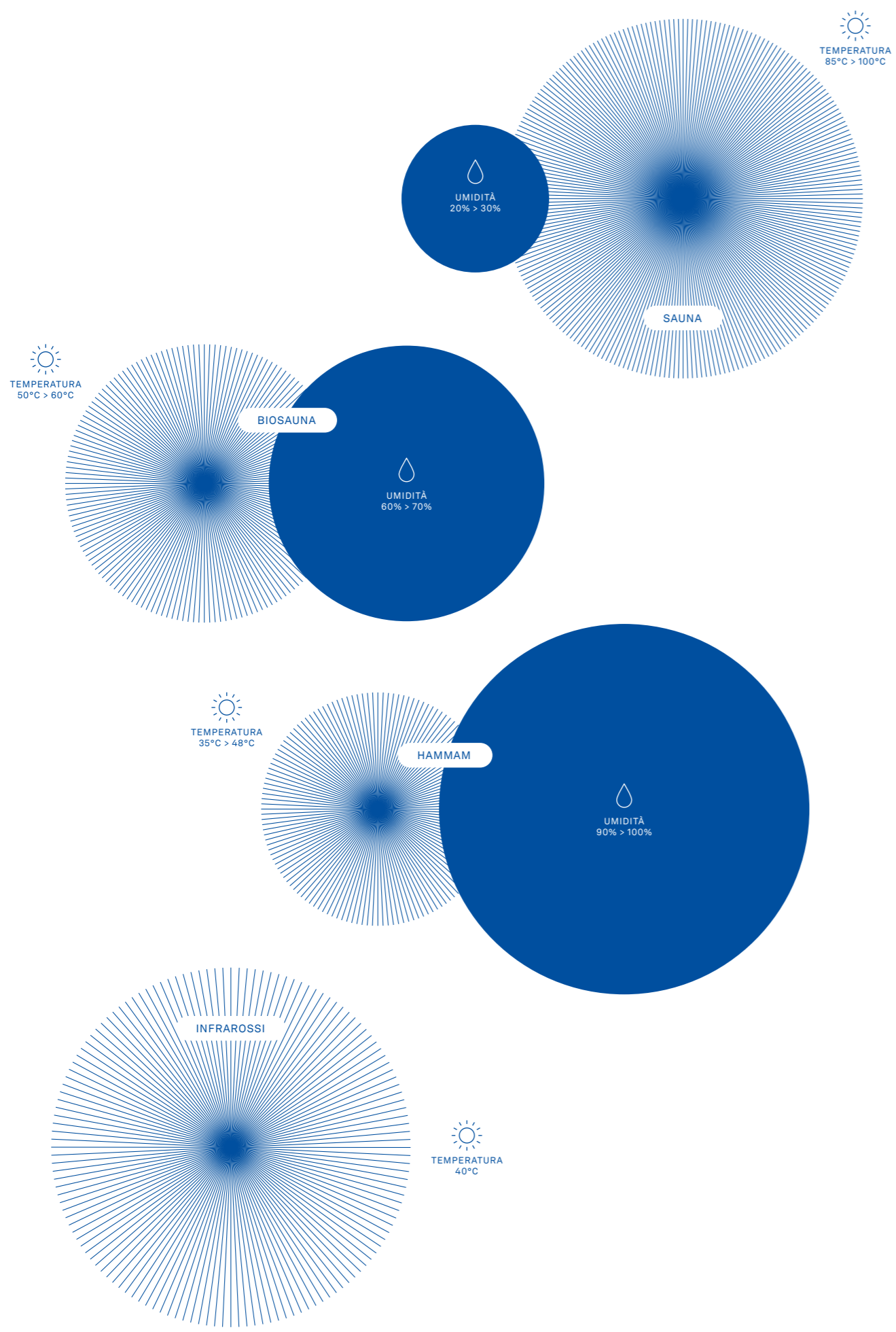

BodyLove

Design: Rodolfo Dordoni, Michele Angelini



VERSIONI DISPONIBILI

SAUNA HAMMAM SAUNA+HAMMAM

38

Logica Plus

Design: Giovanna Talocci, Marco Pallocca



VERSIONI DISPONIBILI

SAUNA+HAMMAM

48

Yoku

Design: Marco Williams Fagioli



VERSIONI DISPONIBILI

SAUNA HAMMAM SAUNA+HAMMAM

60

Natural

Design: Marco Williams Fagioli



VERSIONI DISPONIBILI

SAUNA HAMMAM INFRAROSSI

74

Cabanon

Design: Rodolfo Dordoni, Michele Angelini



VERSIONI DISPONIBILI

SAUNA ESTERNA

86

Aladdin

Design: Rodolfo Dordoni, Michele Angelini

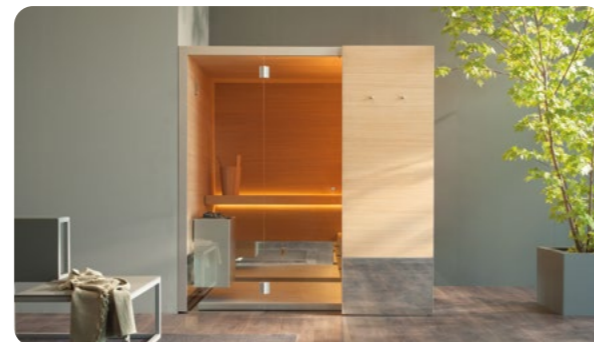

VERSIONI DISPONIBILI

SAUNA

96

Air

Design: Giovanna Talocci



VERSIONI DISPONIBILI

SAUNA

106

Sky

Design: Giovanna Talocci



VERSIONI DISPONIBILI

SAUNA

112

Kanso

Design: Alessandro Andreucci, Christian Hoisl



VERSIONI DISPONIBILI

SAUNA

118

Auki

Design: Giovanna Talocci



VERSIONI DISPONIBILI

SAUNA

126

Idea

Design: Giovanna Talocci, Marco Pallocca

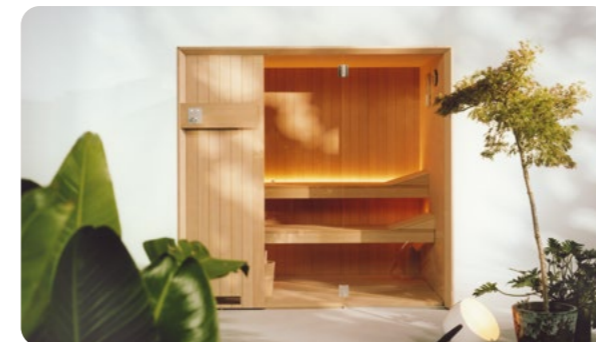

VERSIONI DISPONIBILI

SAUNA INFRAROSSI

132

Touch&Steam Smart

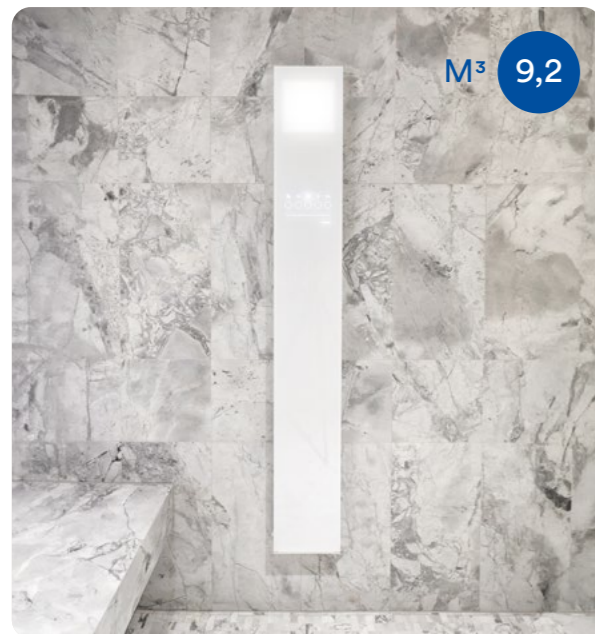

Generatore di vapore interno

140

Inside



Generatore di vapore interno

148

Easystem Smart



Generatore di vapore interno

144

Nuvola Smart



Generatore di vapore esterno

152

PER INFORMAZIONI PIÙ
APPROFONDATE SUI
GENERATORI DI VAPORE EFFE,
CONSULTARE IL CATALOGO
STEAM.



WaterDream

Design: Giovanna Talocci, Marco Pallocca



Minipiscina

158

Sensory Shower



Doccia multisensoriale

164

WaterSuite

Design: Giovanna Talocci, Marco Pallocca



Vasca

158

Porte
e vetrate 168

Sedute 178

Anredi
e accessori 182



Da oltre
35 anni
Effe si dedica
alla perfezione
della tua spa.



MELLINI
35
Y
EXPERIENCE

I prodotti Effe vengono concepiti e costruiti internamente all'azienda, secondo una linea produttiva che permette di avere sotto controllo ogni singolo dettaglio di produzione, in modo da dare al cliente un risultato sempre perfetto. Esiste uno stretto e profondo legame tra gli spazi e il benessere delle persone. I materiali, i riflessi della luce, le temperature, i profumi, i suoni devono saper infondere emozioni e sensazioni positive. Sia in una casa, sia in un ambiente pubblico, personalizzare il proprio angolo di relax significa aumentare benefici per mente e corpo.

I prodotti Effe possono essere adattati a qualunque spazio: costruisci la tua personale area di benessere, ideata su misura per sfruttare al meglio ogni ambiente disponibile.

Effe è in grado di realizzare progetti completamente personalizzati, che prevedono la combinazione di saune, hammam, zone relax, vasche e docce sensoriali: la tua spa ideale.



Centri benessere su misura



PRIVATE HOUSE
ANCONA, ITALY
ARCHITECTURAL CONCEPT AND PROJECT:
STEFANO PETTINARI DESIGNER
PH: MASSIMO SPADA



ONE HIGH LINE
NYC, US
ARCHITECT: BJARKE INGELSGROUP
INTERIORS: GILLES & BOISSIER AND GABELLINI SHEPPARD
PH: STEFANO PASQUALETTI®





LA CASA DEL PORTO
LOVERE, ITALIA









QC TERWE
NYC, US
PH: STEFANO PASQUALETTI©





KALEA BAY WELLNESS CENTER
NAPLES, USA
PH: KRIS TAMBURELLO STUDIOS®



QC TERMEGARDA
LAGO DI GARDA, ITALY

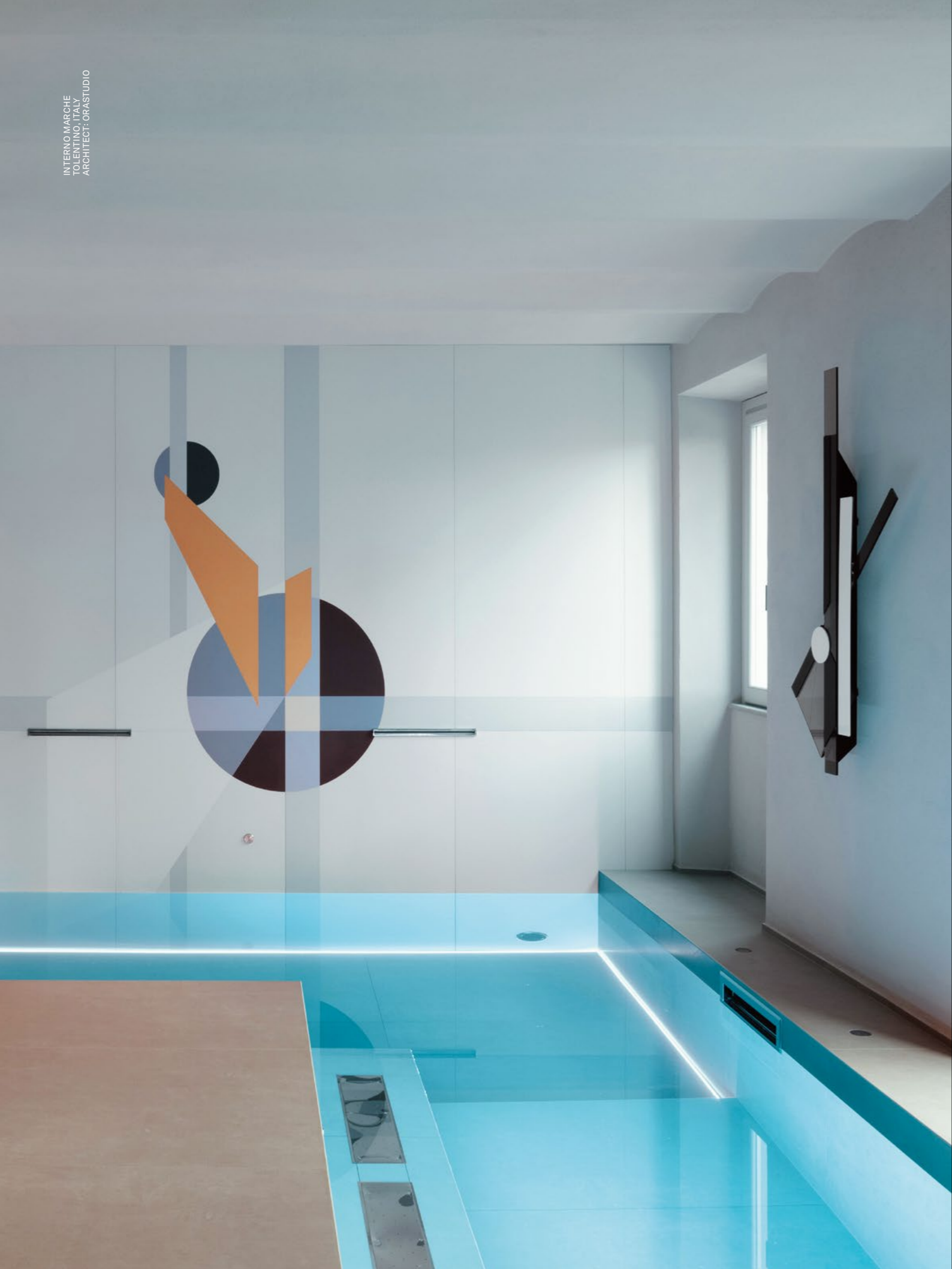



THE SPA AT
MANDARIN ORIENTAL MAYFAIR, LONDRA
PH: PAUL CRAIG®





HOTEL RESORT RE DELLE ALPI
LA THUILE, ITALIA

HOTEL RESORT RE DELLE ALPI
LA THUILLE, ITALIA





La migliore tecnologia al servizio dell'ambiente

Tutto il sistema di produzione Effe è elaborato per ottimizzare al massimo i consumi di energia. L'eccellenza delle soluzioni tecnologiche, sempre all'avanguardia, garantiscono prodotti di qualità certificata, di lunga durata, con manutenzione ridotta e risparmio energetico.



RISPARMIO ENERGETICO

LE SONDE DI CONTROLLO DELLA TEMPERATURA REGOLANO L'EROGAZIONE DEL VAPORE PER OTTENERE SEMPRE IL MASSIMO COMFORT.

DISTRIBUZIONE UNIFORME NEL TEMPO DEI CICLI DI ACCENSIONE E SPEGNIMENTO DELLE TERMORESISTENZE.

NESSUNO SPRECO DI ACQUA

DILUIZIONI E RISCIAQUI INTERMEDI CALCOLATI SU REALE FABBISOGNO.

RIEMPIMENTO AUTOMATICO DELLA CALDAIA IN BASE ALLE NECESSITÀ.

MONITORAGGIO COSTANTE DEL TEMPO DI CARICO E SCARICO ACQUA.

CONFORMITÀ AI REQUISITI ANTI-INQUINAMENTO PER ALLACCIO IDRICO.

MATERIALI ECO-COMPATIBILI

EFFE, AL FINE DI SALVAGUARDARE L'AMBIENTE, DICHIARA CHE IL LEGNO UTILIZZATO PER LA PRODUZIONE DI SAUNE FINLANDESI È CONFORME AGLI STANDARD PEFC ITA 1002 REV. 4, FSC-STD-40-0003 V1-0 E FSC-STD-40-004 V2-0.

PER I PRODOTTI EFFE NON SONO UTILIZZATI LEGNI PROVENIENTI DA DEFORESTAZIONE O LEGNI DI ALBERI IN ESTINZIONE.

AUTO-CONFIGURAZIONE ELETTRONICA

START-UP AUTOMATICO: LA SOFISTICATA ELETTRONICA CONSENTE DI SVOLGERE VELOCEMENTE LO START-UP EVITANDO LA PROCEDURA MANUALE.

IL SISTEMA RICONOSCE AUTOMATICAMENTE LE PERIFERICHE COLLEGATE (LAMPADA CROMO, PANNELLO, ECC.).

FACILI DA INSTALLARE

CONTROCASSA PROGETTATA PER AGEVOLARE I PROCESSI DI INSTALLAZIONE.

IN TUTTI I GENERATORI INTERNI, UNO SPECIFICO CARTER SUPERIORE GARANTISCE L'ANTI-GOCCIOLAMENTO.

PERFETTA TENUTA STAGNA DELLA CONTROCASSA E DEI GENERATORI INTERNI.

VAPORE PERFETTO

FUNZIONE POWER STEAM (PSF) DI SERIE: SPECIALE SISTEMA DI VENTILAZIONE CHE CONSENTE UNA TEMPERATURA UNIFORME IN TUTTO IL VANO HAMMAM.

ALETTE ORIENTABILI PER DIREZIONARE IL VAPORE IN USCITA; VELOCITÀ VENTOLA CONFIGURABILE; LED LUMINOSO ALL'USCITA DEL VAPORE.

DOPPIA SONDA DI TEMPERATURA ALL'INTERNO DEL DIFFUSORE DI VAPORE.

SUPER SILENT STEAM: BASSO LIVELLO DI RUMOROSITÀ DELL'EROGAZIONE VAPORE.

MIGLIORE MANUTENZIONE

SISTEMA IN GRADO DI RILEVARE E SEGNALARE EVENTUALI MALFUNZIONAMENTI DELLE TERMORESISTENZE E DELLA SONDA.

AUTODIAGNOSI: IN CASO DI ANOMALIA IL SISTEMA EFFETTUA UNA PROCEDURA DI RIPRISTINO DELLE ELETTROVALVOLE.

DECALCIFICAZIONE INTELLIGENTE

CONTROLLO AUTOMATICO E RIDUZIONE DEI FENOMENI DERIVANTI DA CONCENTRAZIONE DI CALCIO ED ALTRE SOSTANZE IN ACQUA.

RISCIAQUO AUTOMATICO FINALE 30 MIN DOPO LA FINE DELL'HAMMAM CON DILUIZIONE INIZIALE CON ACQUA FREDDA.

Controllo remoto con l'app My Effe

Connetti i tuoi prodotti, ricevi news e consigli personalizzati per migliorare il tuo stato di benessere e salute.



Effe Sound System

È possibile ascoltare la propria musica preferita all'interno della sauna o dell'hammam utilizzando la connessione Bluetooth del proprio dispositivo. Dotata di due casse stereo, Effe Sound System (ESS) si collega automaticamente agli altoparlanti interni senza dover installare software specifici.





DIFFERENTI OPZIONI
 DI ORIENTAMENTO
 E INGRESSO

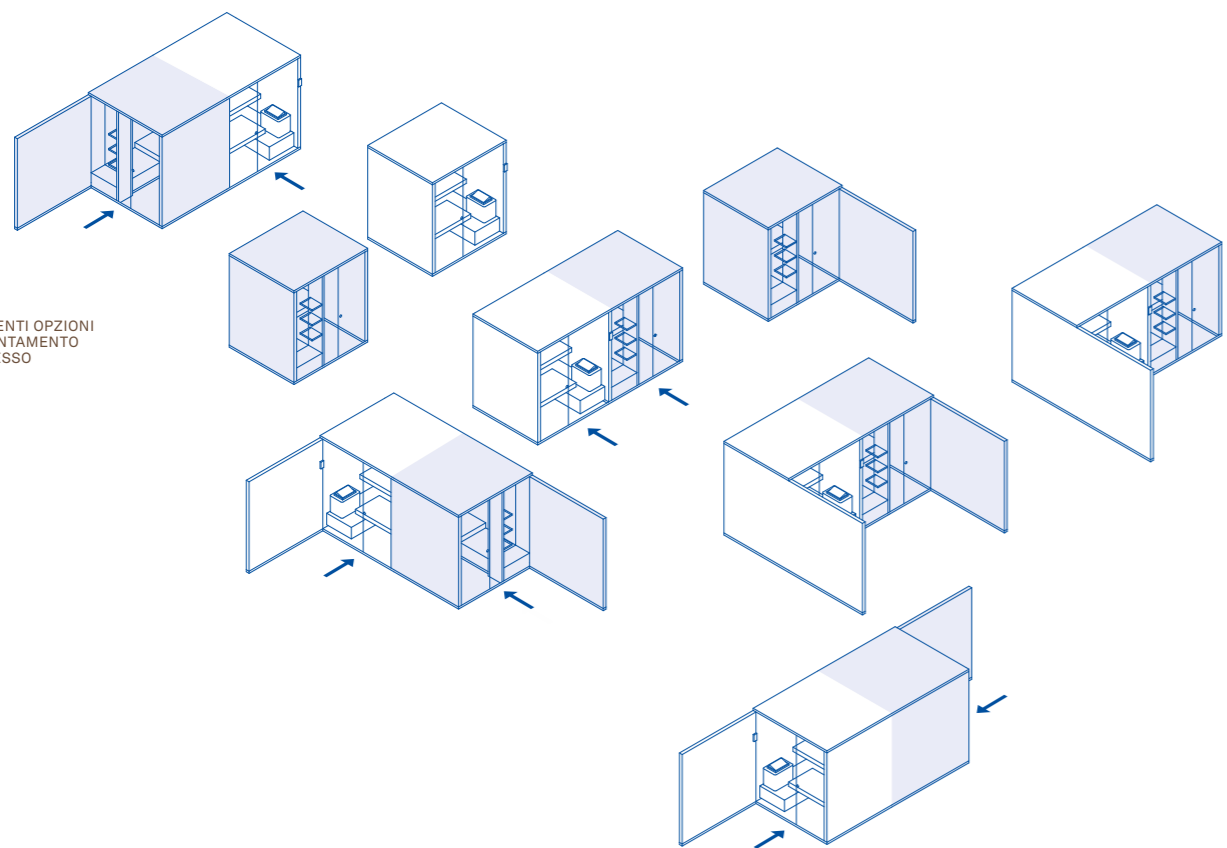

Densità di vapore sempre perfetta.
 Maggiore potenza con basso
 consumo di energia.
 Vapore purificato e sicuro.
 Funziona in completo silenzio.

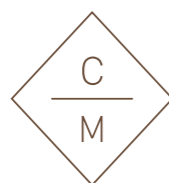

Possibilità di realizzazione
 con dimensioni su misura.

POTENZA ASSORBITA
 15 KW MAX
 8,0 KW SAUNA + 7,0 KW HAMMAM
 230VAC 1N 50-60HZ
 400VAC 3N 50-60HZ

CONTROLLO REMOTO
 GESTIONE A DISTANZA DEL PRODOTTO
 TRAMITE APP MY EFFE

MATERIALI
 > INTERNO ED ARREDI SAUNA:
 LEGNO.
 > RIVESTIMENTO HAMMAM:
 GRES PORCELLANATO.
 > PANCHE HAMMAM:
 CORIAN BONE
 > RIVESTIMENTO INTERNO TETTO:
 GRES PORCELLANATO.
 > PORTE: VETRO TEMPERATO
 EXTRACHIARO 10 MM

BodyLove

Design:
 Rodolfo Dordoni, Michele Angelini

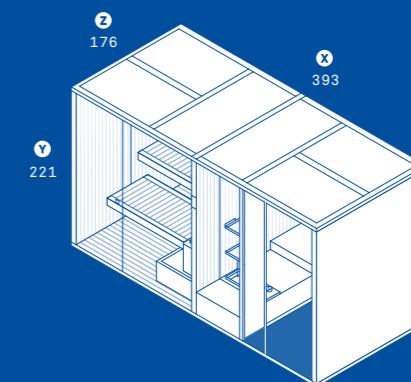

BODYLOVE SH

SAUNA+HAMMAM

X Z Y
 393 x 176 x 221

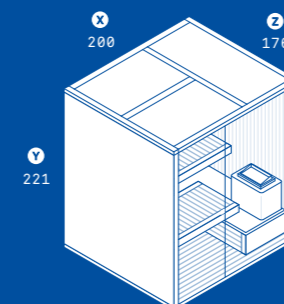

BODYLOVE S

SAUNA

X Z Y
 200 x 176 x 221

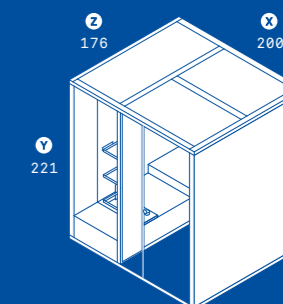

BODYLOVE H

HAMMAM

X Z Y
 200 x 176 x 221

BodyLove è sistema modulare che consente molte combinazioni per l'arredo di una spa. Questa collezione si distingue per i materiali di pregio assoluto, le texture personalizzate del legno, gli straordinari abbinamenti cromatici e materici, la boiserie esterna e i dettagli costruttivi unici progettati con eleganza da Rodolfo Dordoni. Le composizioni di BodyLove sono in grado di arricchire lo stile e la personalità dell'area benessere.

BODYLOVE SH

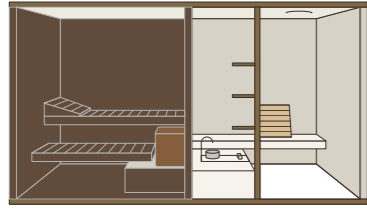

LEGNO TERMOTRATTATO SCURO
GRES PORCELLANATO CHAMPAGNE

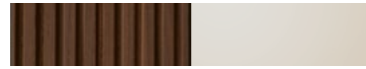
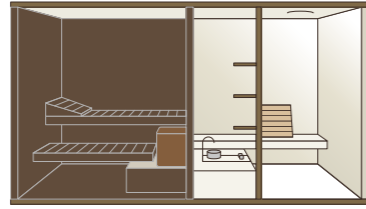

LEGNO TERMOTRATTATO SCURO
VETRO LISCIO

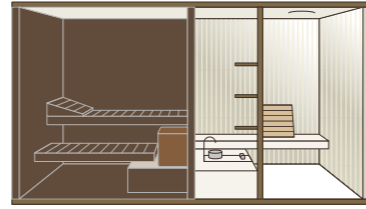

LEGNO TERMOTRATTATO SCURO
VETRO A CANNE SCURO

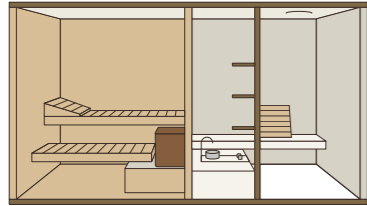

HEMLOCK CANADESE
GRES PORCELLANATO CHAMPAGNE

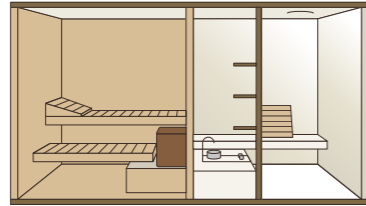

HEMLOCK CANADESE
VETRO LISCIO



HEMLOCK CANADESE
VETRO A CANNE (FLUTES)

BODYLOVE S

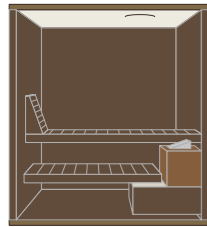

LEGNO TERMOTRATTATO SCURO

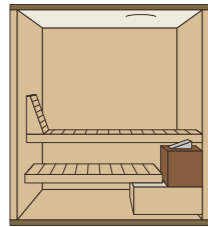

HEMLOCK CANADESE

BODYLOVE H



GRES PORCELLANATO CHAMPAGNE

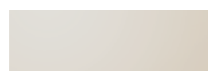

VETRO LISCIO



VETRO A CANNE (FLUTES)

HEMLOCK CANADESE
+ VETRO A CANNE (FLUTES)



BODYLOVE SH
SAUNA+
HAMMAM

LEGNO TERMOTRATTATO SCURO
+ VETRO A CANNE (FLUTES)



BODYLOVE SH
SAUNA+
HAMMAM

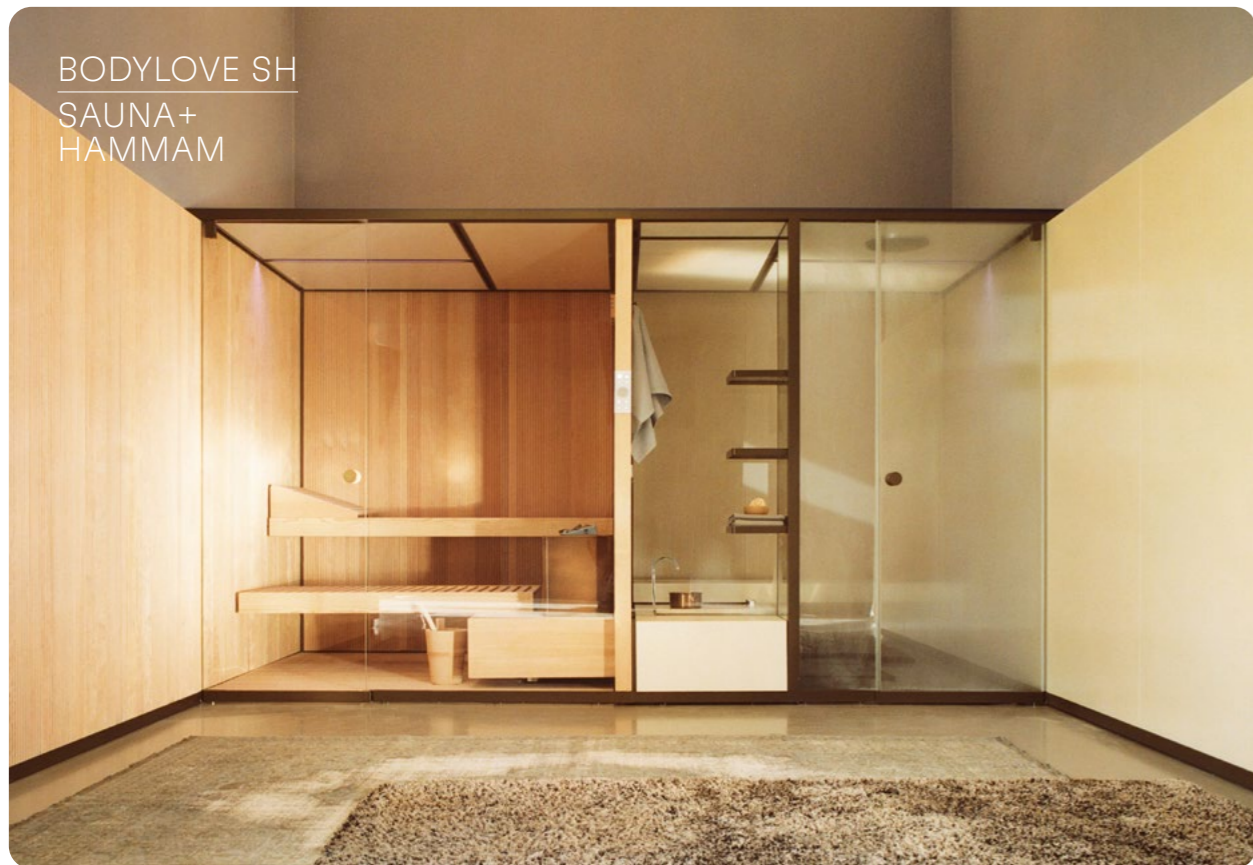

PANNELLATURA ESTERNA
IN HEMLOCK CANADENSE
+ VETROA CANNE (PLUTES)



SAUNA IN LEGNO
TERMOTRATTATO SCURO
(TEXTURE BODYLOVE)

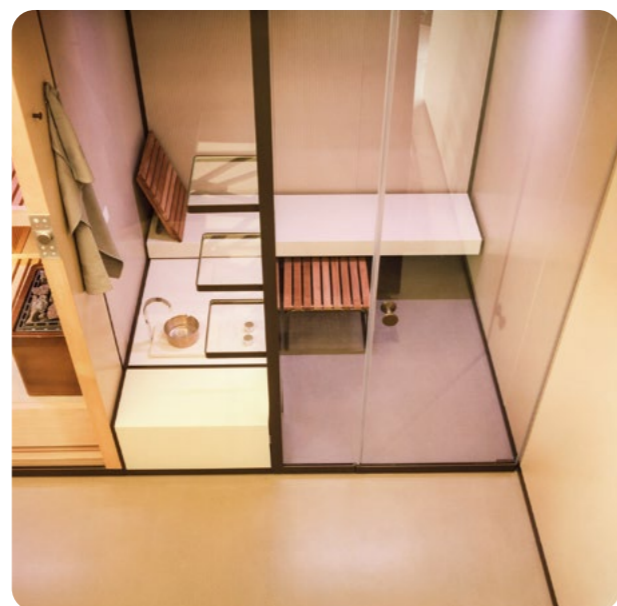

FONTE IN
MARMO BOTTICINO

SAUNA: LEGNO TERMOTRATTATO
SCURO (TEXTURE BODYLOVE)
HAMMAM: GRES PORCELLANATO
CHAMPAGNE



BODYLOVE S
SAUNA



RIVESTIMENTO INTERNO
ED ESTERNO IN GRES
PORCELLANATO CHAMPAGNE



BODYLOVE H
HAMMAM

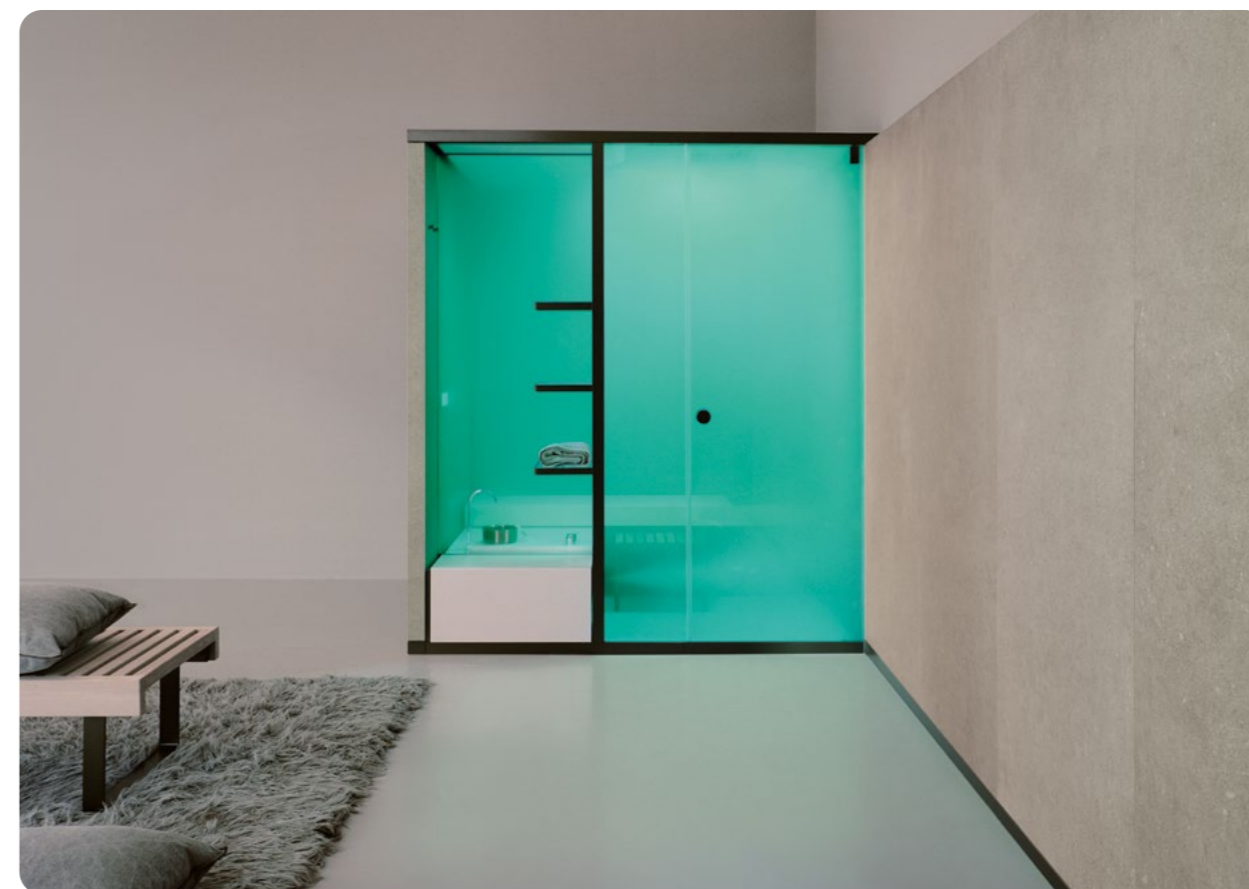

BODYLOVE SH
SAUNA+
HAMMAM



LEGNO TERMOTRATTATO SCURO
+ VETRO A CANNE (FLUTES)

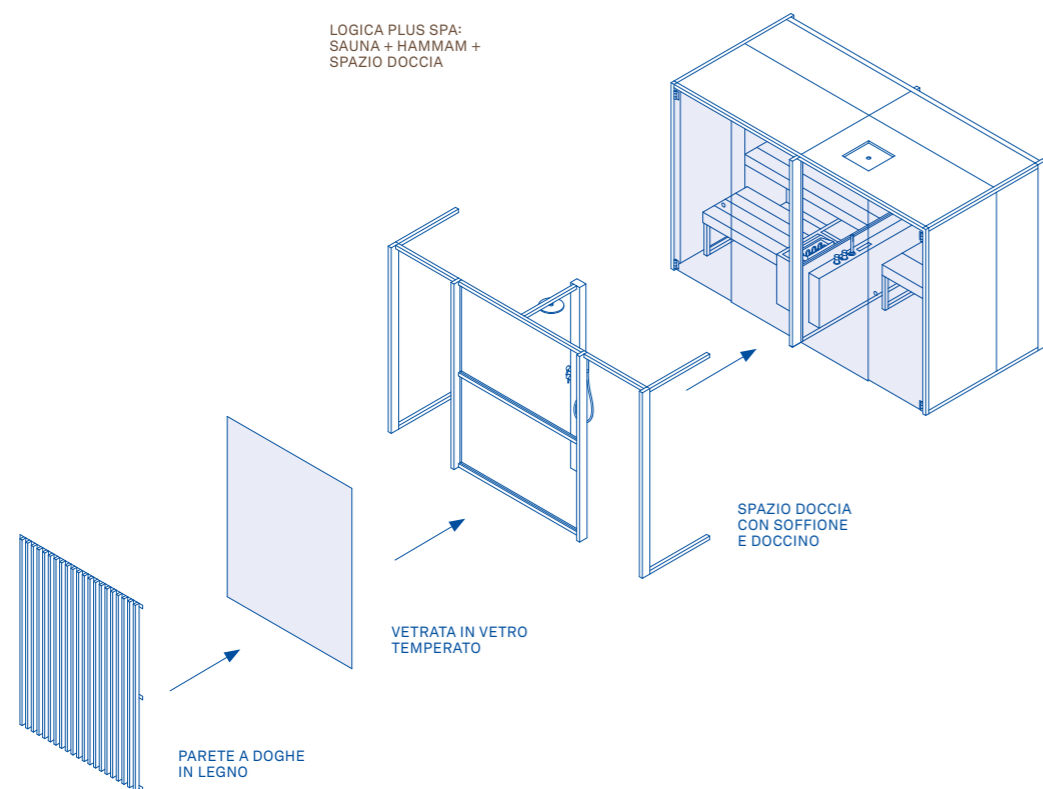

Densità di vapore sempre perfetta.
 Maggiore potenza con basso
 consumo di energia.
 Vapore purificato e sicuro.
 Funziona in completo silenzio.

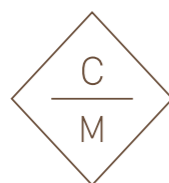

Possibilità di realizzazione
 con dimensioni su misura.

POTENZA ASSORBITA
SPA / SH
 15 KW MAX
 8,0 KW SAUNA + 7,0 KW HAMMAM
 230VAC 1N 50-60HZ
 400VAC 3N 50-60HZ

MID
 10,5 KW MAX
 6 KW SAUNA + 4,5 KW HAMMAM
 230VAC 1N 50-60HZ
 400VAC 3N 50-60HZ

CONTROLLO REMOTO
 GESTIONE A DISTANZA DEL PRODOTTO
 TRAMITE APP MY EFFE

MATERIALI
SAUNA
 > INTERNO/ESTERNO/ARREDI:
 ASPEN TERMOTRATTATO
HAMMAM
 > INTERNO/ARREDI:
 GRES LAMINATO 3.5 MM, FINITURA
 PELT
 > PANCA CON STRUTTURA IN
 ALLUMINIO E PIANO IN GRES
 SLIMTECH PELT
DOCCIA (SOLO SPA):
 > MENSOLA/GRIGLIATO ESTERNO
 IN LEGNO ASPEN TERMOTRATTATO
 > VETRI FISSI 6 MM
STRUTTURA
 > PORTE E VETRATA FRONTALE
 IN VETRO TEMPERATO 8 MM
 > STRUTTURA IN ALLUMINIO
 VERNICIATO GREY BEIGE

Logica Plus

Design:
 Giovanna Talocci, Marco Pallocca

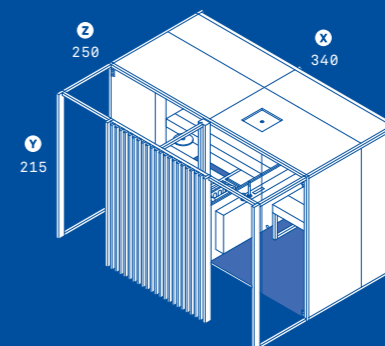

LOGICA PLUS SPA

SAUNA+HAMMAM+DOCCIA

X Z Y
 340 x 250 x 215

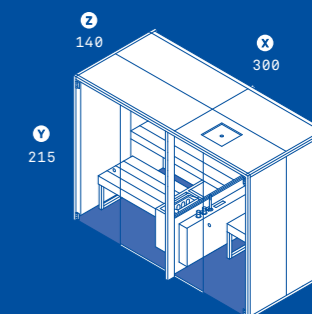

LOGICA PLUS MID

SAUNA+HAMMAM

X Z Y
 300 x 140 x 215

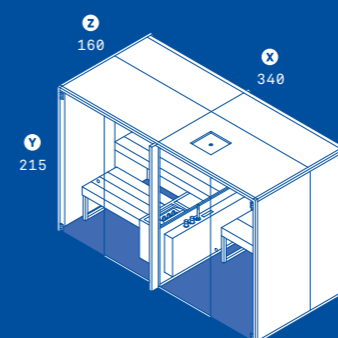

LOGICA PLUS SH

SAUNA+HAMMAM

X Z Y
 340 x 160 x 215

Logica Plus rappresenta l'ultima evoluzione della
 linea di prodotti Logica e combina in
 un unico ambiente sauna, hammam e doccia
 (versione Spa). Il design, elegante e minimalista, è
 caratterizzato da una struttura in alluminio leggera e
 da rivestimenti in materiali pregiati come il gres e
 l'Aspen termotrattato, che conferiscono un'atmosfera
 calda e accogliente. Elementi distintivi sono gli
 specchi, che collegano orizzontalmente
 gli spazi, e la parete vetrata che separa sauna
 e hammam, creando un senso di continuità
 e ampliando lo spazio percepito.

LOGICA PLUS SPA

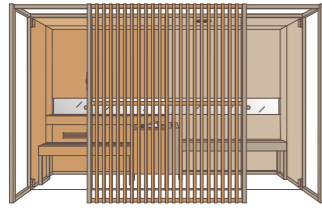

ASPEN
TERMOTRATTATO

GRES PORCELLANATO
LAMINATO: SLIMTECH
PELT

ALLUMINIO VERNICIATO
GRIGIO BEIGE

LOGICA PLUS SH



ASPEN
TERMOTRATTATO

GRES PORCELLANATO
LAMINATO: SLIMTECH
PELT

ALLUMINIO VERNICIATO
GRIGIO BEIGE

LOGICA PLUS MID

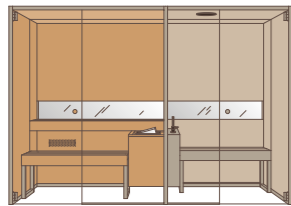

ASPEN
TERMOTRATTATO

GRES PORCELLANATO
LAMINATO: SLIMTECH
PELT

ALLUMINIO VERNICIATO
GRIGIO BEIGE



LOGICA PLUS SPA
SAUNA+
HAMMAM+
DOCCIA



LOGICA PLUS SH
SAUNA+
HAMMAM

LOGICA PLUS SPA
SAUNA+
HAMMAM+
DOCCIA



ASPEN TERMOTRATTATO +
STRUTTURA IN ALLUMINIO
VERNICIATO GRIGIO BEIGE

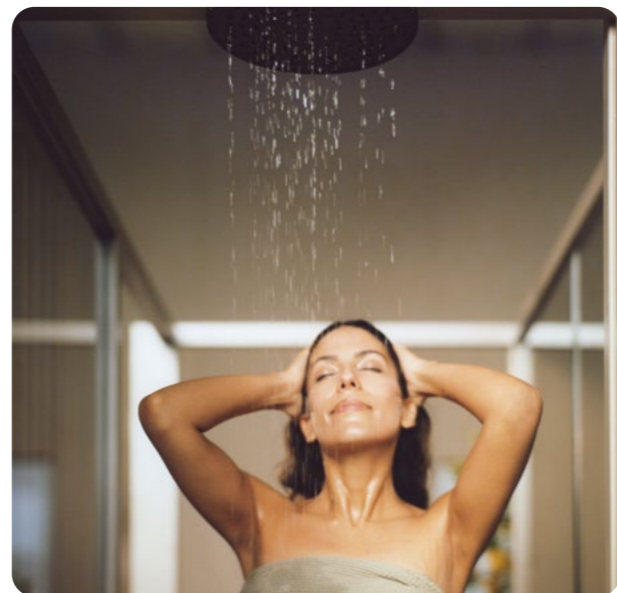

VANO DOCCIA CON
SOPFIONE E RUBINETTERIA
IN NERO OPACO

LOGICA PLUS SH
SAUNA+
HAMMAM+



ILLUMINAZIONE A LED RGB:
5 COLORI FISSI, 4 CICLI
DINAMICI E LUCE BIANCA



ASPEN, TERMOTRATTATO +
GRES PORCELLANATO PELT +
STRUTTURA IN ALLUMINIO
VERNICIATO GREY BEIGE



ACCESSORIO
PORTASCIUGAMANO
PER INCASSO A PARETE
(OPTIONAL)

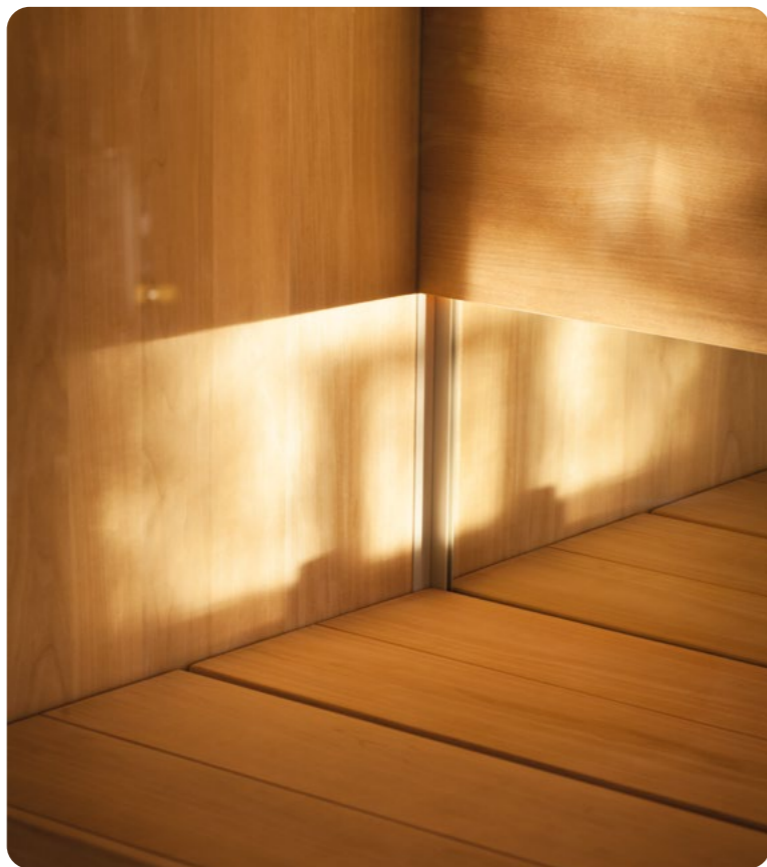

PREGIATO LEGNO DI ASPEN
TERMOTRATTATO E SPECCHI
CARATTERIZZANO L'INTERNO
DELLA SAUNA

PANNELLO DI
CONTROLLO HAMMAM
E RUBINETTERIA



LOGICA PLUS MID
SAUNA+
HAMMAM



ASPEN TERMOTRATTATO +
GRES PORCELLANATO PELT +
STRUTTURA IN ALLUMINIO
VERNICIATO GRIGIO BEIGE



LOGICA PLUS SPA
SAUNA+
HAMMAM+
DOCCIA



ASPEN TERMOTRATTATO +
GRES PORCELLANATO PELT +
FRUTTA ALLUONIO
VERNICIATO GRIGIO BEIGE





DIFFERENTI OPZIONI
 DI ABBINAMENTO
 CON IL MODULO
 LIBRERIA

YOKU SH
 DOOR

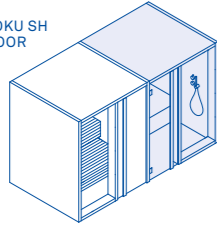

YOKU SH
 SHELF

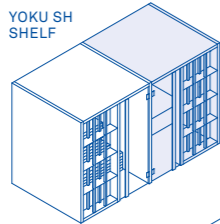

YOKU SH
 GLASS

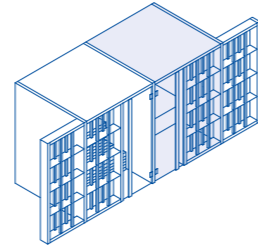
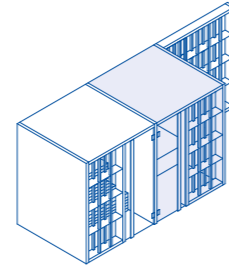
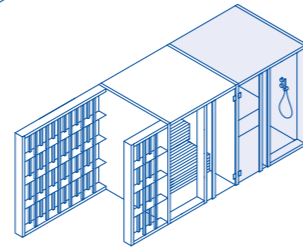
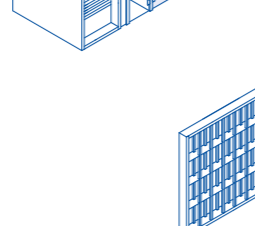
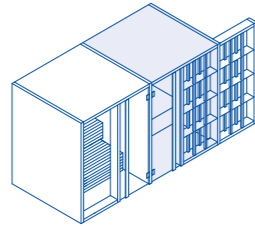
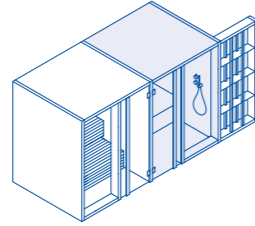
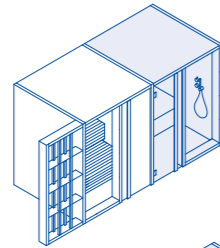
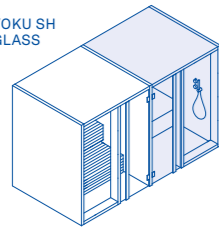

Densità di vapore sempre perfetta.
 Maggiore potenza con basso
 consumo di energia.
 Vapore purificato e sicuro.
 Funziona in completo silenzio.

Possibilità di realizzazione
 con dimensioni su misura.

POTENZA ASSORBITA
 10,5 KW MAX
 6,0 KW SAUNA + 4,5 KW HAMMAM
 230VAC 1N 50-60HZ
 400VAC 3N 50-60HZ

CONTROLLO REMOTO
 GESTIONE A DISTANZA DEL
 PRODOTTO TRAMITE APP MY EFFE

MATERIALI
 > INTERNO ED ARREDI SAUNA:
 LEGNO
 > INTERNO ED ARREDI HAMMAM:
 GRES PORCELLANATO
 > PARETI ESTERNE A VISTA:
 LEGNO
 > PORTE: VETRI TEMPERATI CHIARI
 DA 8 MM CON CERNIERE E
 FINITURA IN ALLUMINIO
 SPAZZOLATO

Yoku

Design:
 Marco Williams Fagioli

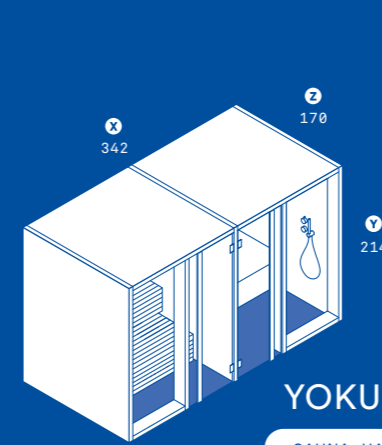

YOKU SH

SAUNA+HAMMAM

X Z Y
 342 x 170 x 214

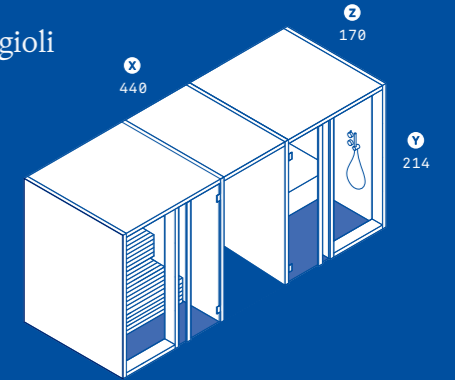

YOKU SPA

SAUNA+HAMMAM+DOCCIA

X Z Y
 444 x 170 x 214

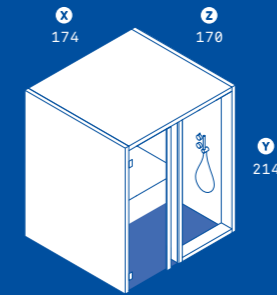

YOKU H

HAMMAM

X Z Y
 174 x 170 x 214

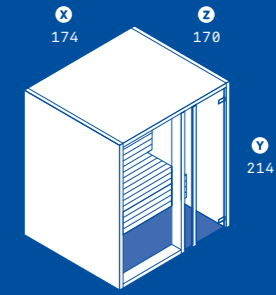

YOKU S

SAUNA

X Z Y
 230 x 200 x 214 YOKU S 105
 202 x 180 x 214 YOKU S 80
 174 x 170 x 214 YOKU S 60
 174 x 132 x 214 YOKU S 45

Yoku è un sistema modulare molto versatile,
 ideale per ambienti residenziali o pubblici.
 Il design si contraddistingue per l'esteso utilizzo
 del legno e per le tre differenti declinazioni del fronte:
 Shelf, Glass e Door. Shelf è caratterizzata da un
 modulo libreria che personalizza il prodotto e crea
 un filtro con lo spazio interno, per un'esperienza
 di benessere più intima. Door prevede una porta
 in legno con maniglia a tutta altezza che richiama
 la tradizione. Glass ha un design minimale e luminoso,
 grazie alla parte frontale vetrata.

YOKU SPA

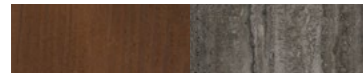

LEGNO TERMOTRATTATO SCURO
TRAVERTINO DARK



LEGNO TERMOTRATTATO SCURO
GRES PORCELLANATO FIOR DI BOSCO TORTORA



NOCE CANALETTO
GRES PORCELLANATO CALACATTA GOLD EXTRA

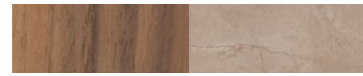

NOCE CANALETTO
GRES PORCELLANATO FIOR DI BOSCO TORTORA

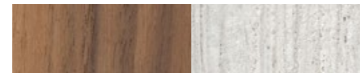

NOCE CANALETTO
TRAVERTINO LIGHT



NOCE CANALETTO
TRAVERTINO DARK



ASPEN TERMOTRATTATO
GRES PORCELLANATO CALACATTA GOLD EXTRA



ASPEN TERMOTRATTATO
TRAVERTINO LIGHT

YOKU SH

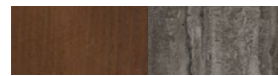
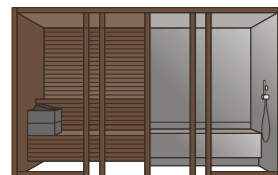

LEGNO TERMOTRATTATO SCURO
TRAVERTINO DARK

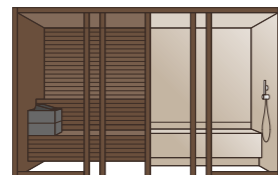

LEGNO TERMOTRATTATO SCURO
GRES PORCELLANATO FIOR DI BOSCO TORTORA

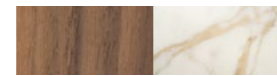
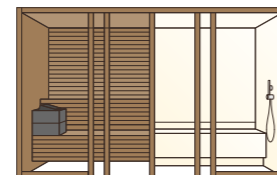

NOCE CANALETTO
GRES PORCELLANATO CALACATTA GOLD EXTRA

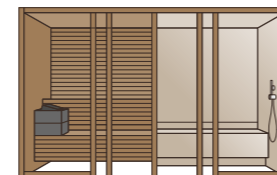

NOCE CANALETTO
GRES PORCELLANATO FIOR DI BOSCO TORTORA

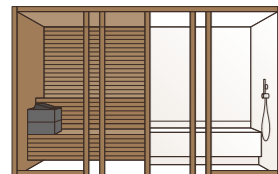

NOCE CANALETTO
TRAVERTINO LIGHT

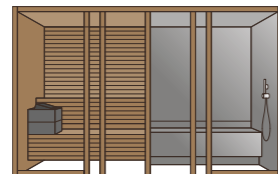

NOCE CANALETTO
TRAVERTINO DARK

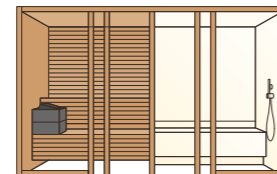

ASPEN TERMOTRATTATO
GRES PORCELLANATO CALACATTA GOLD EXTRA

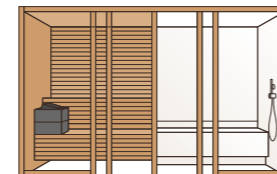

ASPEN TERMOTRATTATO
TRAVERTINO LIGHT

YOKU S

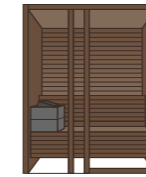

LEGNO TERMOTRATTATO SCURO

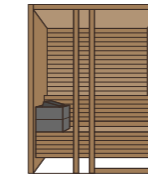

NOCE CANALETTO

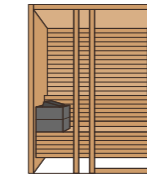

ASPEN TERMOTRATTATO

YOKU H

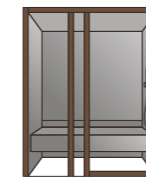

LEGNO TERMOTRATTATO SCURO
TRAVERTINO DARK

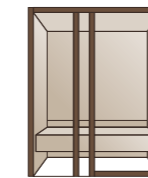

LEGNO TERMOTRATTATO SCURO
GRES PORCELLANATO FIOR DI BOSCO TORTORA

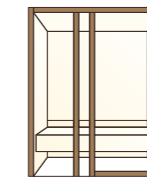

NOCE CANALETTO
GRES PORCELLANATO CALACATTA GOLD EXTRA

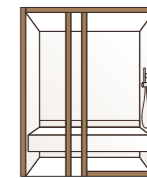

NOCE CANALETTO
TRAVERTINO LIGHT

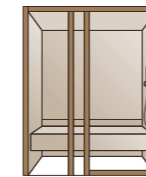

NOCE CANALETTO
GRES PORCELLANATO FIOR DI BOSCO TORTORA

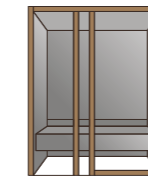

NOCE CANALETTO
TRAVERTINO DARK

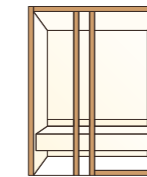

ASPEN TERMOTRATTATO
GRES PORCELLANATO CALACATTA GOLD EXTRA

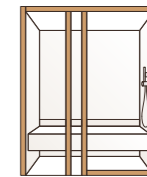

ASPEN TERMOTRATTATO
TRAVERTINO LIGHT

YOKU SPA SHELF

Nella versione Shelf, la parte frontale diventa una grande "libreria" aperta con ripiani in acciaio. Funziona come un filtro naturale e accoglie oggetti, libri e tessuti, conferendo un aspetto altamente personalizzato e in armonia con l'ambiente della spa.



YOKU SPA DOOR

Nella versione Door l'ampia superficie della porta in legno stabilisce un legame forte con la sauna tradizionale, chiusa e protetta. La maniglia a tutta altezza diviene elemento formale ricercato e funzionale.



YOKU SPA GLASS

La versione Glass regala una forte sensazione di trasparenza e luminosità. L'estetica pulita e razionale esalta i dettagli stilistici del prodotto, come le vetrate arretrate con cornice in legno da 20 cm.





YOKU SPA SHELF



YOKU SPA
SAUNA+
HAMMAM+
DOCCIA



YOKU SH GLASS

YOKU SH DOOR.
ASPEN TERMOTRATTATO
+ GRES PORCELLANATO
CALACATTA GOLD EXTRA.
VETRI BRONZATI E CERNIERE
IN FINITURA INOX SATINATO
PVD (OPTIONAL)



YOKU SH
SAUNA+
HAMMAM



YOKU S DOOR.
MODULO LIBRERIA ESTERNO
(OPZIONALE)



YOKU S
SAUNA

YOKU S GLASS.
STRUTTURA E INTRNO SAUNA
IN NOCE CANALETTO.
MODULO LIBRERIA ESTERNO
(OPZIONALE)





YOKU H GLASS.
STRUTTURA IN ASPEN
PANNELLO IN TRAVERTINO
GRES PORCELANATO CALA CATTA
EXTRA GOLD, MODULO LIBRERIA
ESTERNO (OPZIONALE)

YOKU H GLASS.
STRUTTURA IN NOCE CANALETTO,
HAMMAM IN TRAVERTINO LIGHT



YOKU H GLASS.
STRUTTURA IN LEGNO
TERMOTRATTATO SCURO,
HAMMAM IN TRAVERTINO DARK

YOKU H
HAMMAM



YOKU SH
SAUNA+
HAMMAM

YOKU SH SHELF,
ASPEN TERMOTRATTO
+ GRÉS PORCELLANATO
CALACATTA GOLD EXTRA
VETRI BRONZATI E CERNIERE
IN FINITURA INOX SATINATO
PVD (OPTIONAL)

SAUNA IN NOCE CANALETTO.
STUFA CON COPERTURA PROTETTIVA
IN ACCIAIO NATURALE





DIFFERENTI OPZIONI
DI ORIENTAMENTO
E INGRESSO

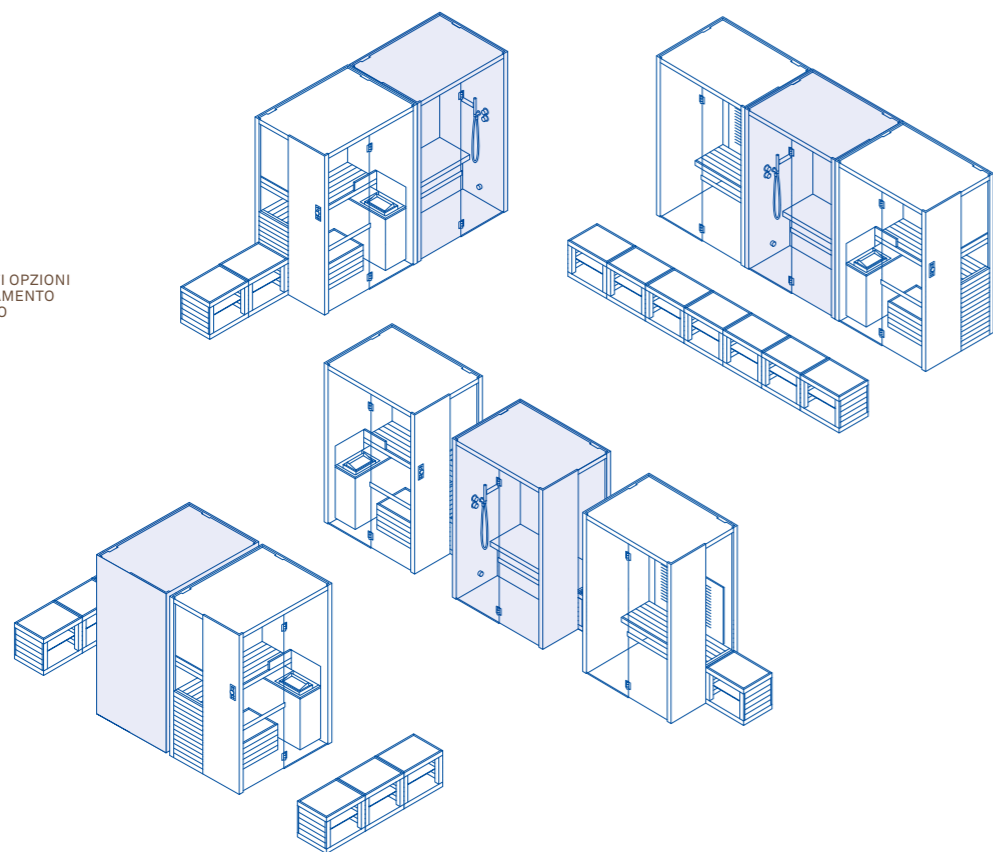

Densità di vapore sempre perfetta.
Maggiore potenza con basso
consumo di energia.
Vapore purificato e sicuro.
Funziona in completo silenzio.

POTENZA ASSORBITA
SAUNA E HAMMAM
3 KW MAX
230VAC 1N 50-60HZ
400VAC 3N 50-60HZ

INFRAROSSI
1 KW MAX
230VAC 1N 50-60HZ
N° 2 EMETTITORI AD IR A LARGO
SPETTRO DI POTENZA
500 W CADAUNO

CONTROLLO REMOTO
GESTIONE A DISTANZA DEL PRODOTTO
TRAMITE APP MY EFFE

MATERIALI
NATURAL S/IR
> INTERNO/ESTERNO/ARREDI:
ASPEN TERMOTRATTATO
NATURAL H
> ESTERNO: ASPEN TERMOTRATTATO
> INTERNO ED ARREDI:
GRES LAMINATO 6 MM
NATURAL S/IR/H
> PORTA E VETRATA FRONTALE
IN VETRO TEMPERATO 8 MM
> VETRATA LATERALE: VETRO EXTRA
CHIARO SATINATO, TEMPERATO 8 MM
> CERNIERE IN ALLUMINIO
SPAZZOLATO

Natural

Design:
Marco Williams Fagioli

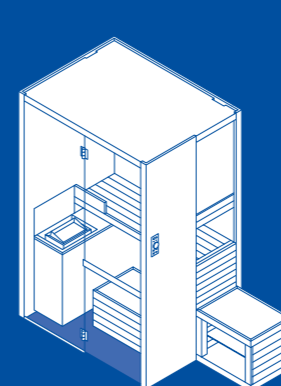

NATURAL S

SAUNA

X Z Y
140 x 105 x 214

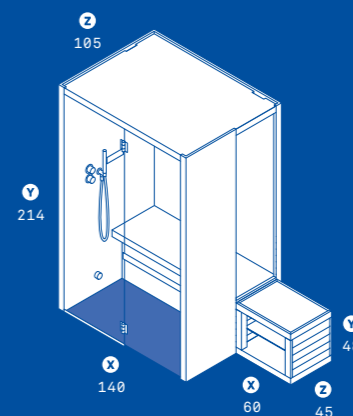

NATURAL H

HAMMAM

X Z Y
140 x 105 x 214

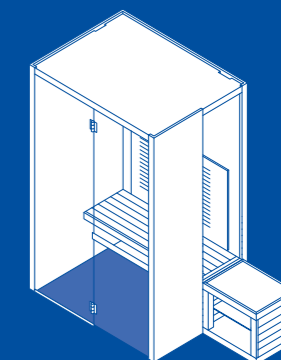

NATURAL IR

INFRAROSSI

X Z Y
140 x 105 x 214

Natural è la collezione firmata da Marco Williams Fagioli dedicata alle 3 terapie del calore: sauna, hammam e infrarossi. Il coordinamento estetico dei prodotti, realizzati in pregiato legno Aspen termotrattato, e le dimensioni contenute permettono un facile inserimento anche negli spazi domestici. Il design di questa collezione valorizza l'ergonomia degli spazi e permette un risparmio energetico significativo grazie ad un volume ridotto.

NATURAL S

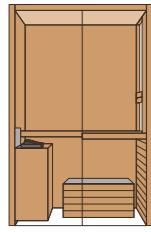

ASPEN
TERMOTRATTATO

SLIMTECH CONCRETO
MEDIUM

NATURAL H

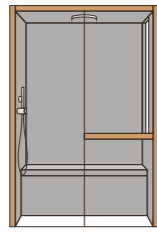

ASPEN
TERMOTRATTATO

SLIMTECH CONCRETO
MEDIUM

NATURAL IR

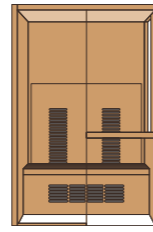

ASPEN
TERMOTRATTATO

SLIMTECH CONCRETO
MEDIUM

NATURAL S
SAUNA

OPTIONAL

PANCHETTA

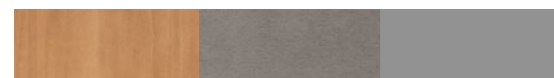
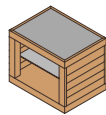

ASPEN
TERMOTRATTATO

SLIMTECH CONCRETO
MEDIUM

SCAFFALE INTERNO IN
ALLUMINIO RAL 7036





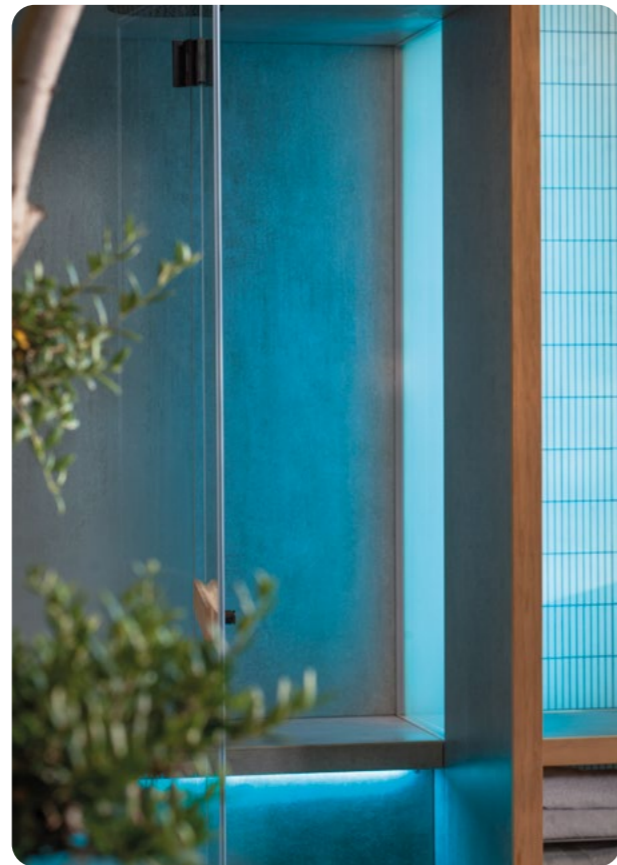

PANCHETTA ESTERNA
IN ASPEN TERMOTRATTATO
(60 X 45 X 48 CM)

SOFFIONE A PIOGGIA Ø 24 CM,
MISCELATORE E DEVIATORE DOCCIA
AD INCASSO, DOCCIA A MANO CON FLESSIBILE,
FINITURA: MATT GUN METAL PVD

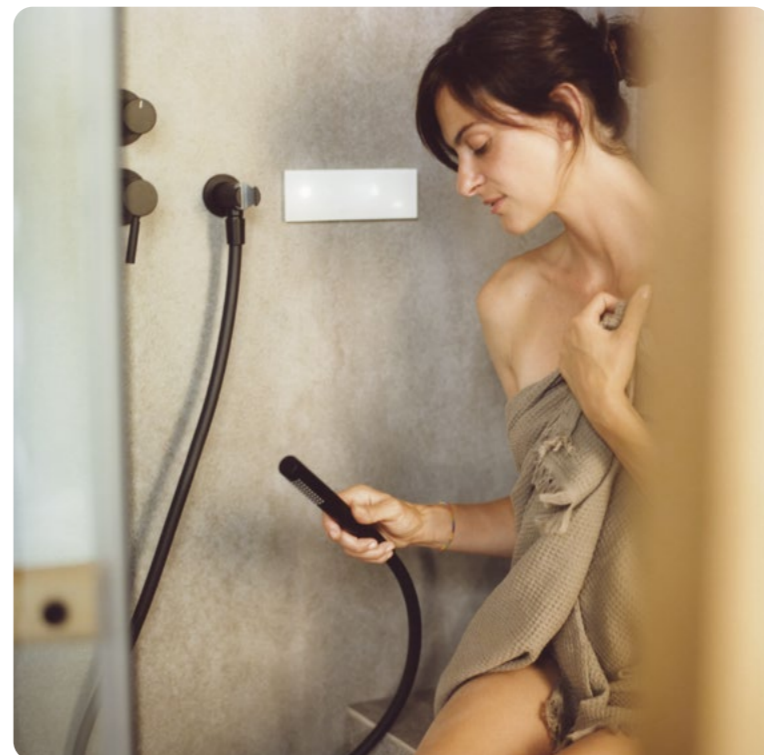



NATURAL S
SAUNA

LAMPADA IR SOTTOPANCA
DA 350 W (OPTIONAL)

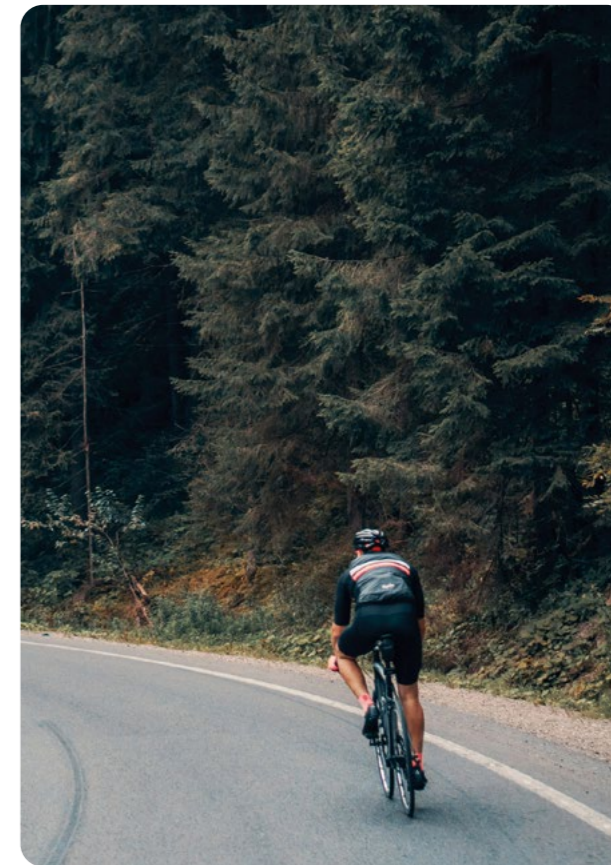

STRUTTURA E INTERNI
IN ASPEN TRATTATO

STRUTTURA E INTERNI
IN ASPEN TRATTATO



NATURAL IR
INFRAROSSI

NATURAL S
SAUNA



STRUTTURA E INTERNI
IN ASPEN TRATTATO
+ FINITURE IN SLIMTECH
GRES CONCRETO MEDIUM



STRUTTURA
 IN ALLUMINIO

LA STRUTTURA MODULARE
 IN ALLUMINIO, LEGGERA E
 FACILMENTE ASSEMBLABILE,
 SEMPLIFICA MONTAGGIO,
 SPOSTAMENTO E
 ADATTABILITÀ A NUOVI SPAZI

RIVESTIMENTO
 INTERNO

RIVESTIMENTO
 ESTERNO

CABANON GARDEN: LA PORTA
 VETRATA HA UNA SIMMETRICA
 APERTURA IN VETRO SUL
 LATO OPPOSTO

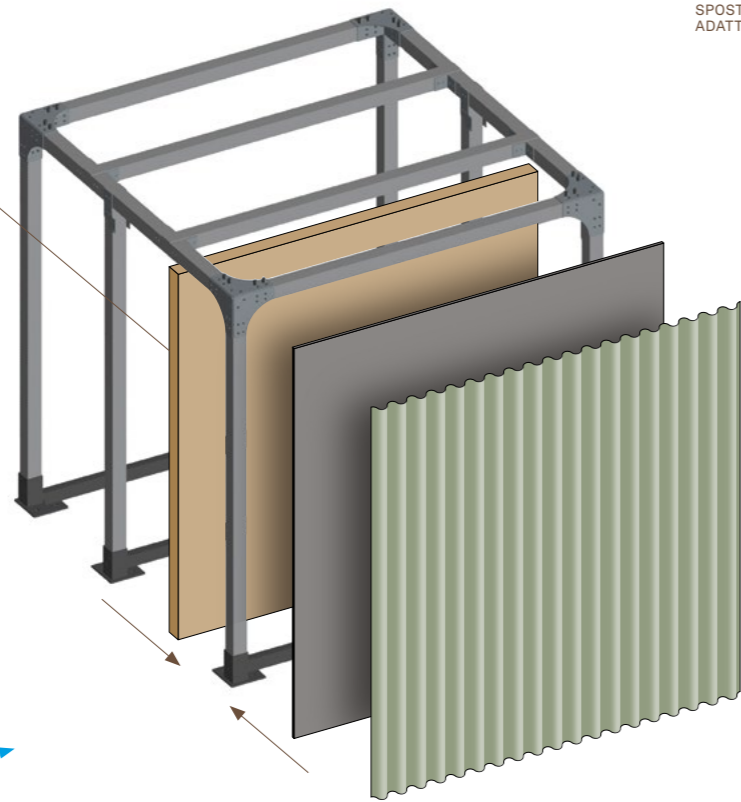
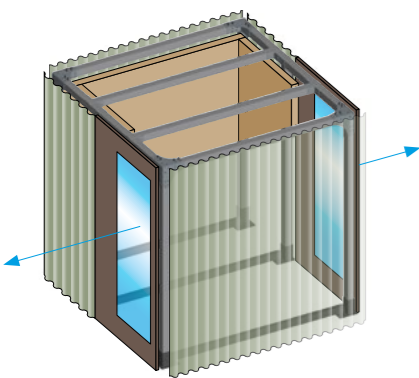

POTENZA ASSORBITA
 4 – 8 KW MAX
 230VAC 1N 50-60HZ
 400VAC 3N 50-60HZ

CONTROLLO REMOTO
 GESTIONE A DISTANZA DEL PRODOTTO
 TRAMITE APP MY EFFE

MATERIALI
 > ESTERNO:
 ALLUMINIO VERNICIATO
 > PORTA E VETRATA:
 VETROCAMERA 24 MM
 > INTERNO ED ARREDI:
 ASPEN TERMOTRATTATO /
 LEGNO TERMOTRATTATO SCURO

Cabanon

Design:
 Rodolfo Dordoni, Michele Angelini

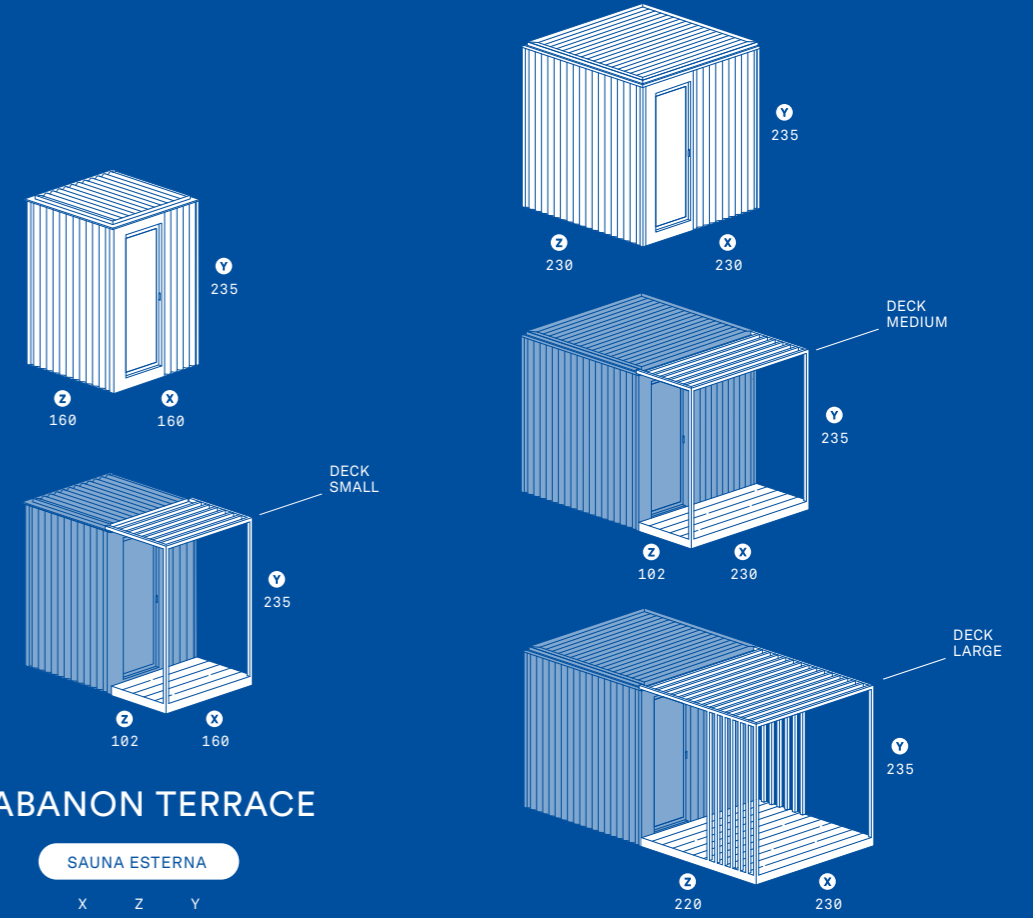

Questo progetto di Rodolfo Dordoni coglie lo spirito originale della sauna finlandese, concepita nei paesi di origine come ambiente autonomo esterno alla casa, in un armonioso rapporto con la natura. Cabanon è progettata per adattarsi a diversi contesti: la versione Terrace, compatta e ideale per terrazze o attici urbani grazie alle dimensioni contenute, e la versione Garden, pensata per grandi spazi, con la possibilità di abbinare una piccola area relax esterna.

CABANON TERRACE



ALLUMINIO ONDULATO
COLORE "MUSCHIO" ALLUMINIO COLORE
"WALNUT"



ALLUMINIO ONDULATO
COLORE "MATTONE" ALLUMINIO COLORE
"WALNUT"

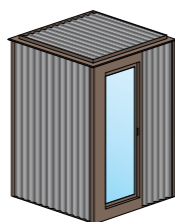

ALLUMINIO ONDULATO
COLORE "CEMENTO" ALLUMINIO COLORE
"WALNUT"

CABANON GARDEN

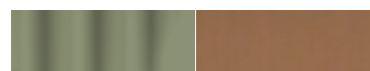
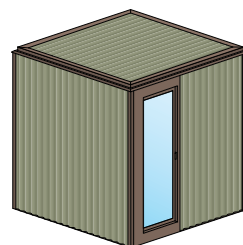

ALLUMINIO ONDULATO
COLORE "MUSCHIO" ALLUMINIO COLORE
"WALNUT"

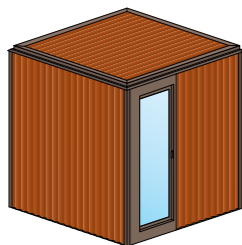

ALLUMINIO ONDULATO
COLORE "MATTONE" ALLUMINIO COLORE
"WALNUT"

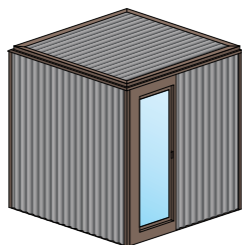

ALLUMINIO ONDULATO
COLORE "CEMENTO" ALLUMINIO COLORE
"WALNUT"

INTERIORS

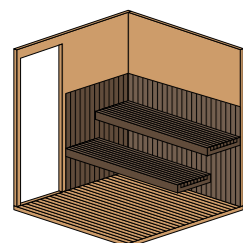

ASPEN
TERMOTRATTATO LEGNO TERMOTRATTATO
SCURO (DOGHE)

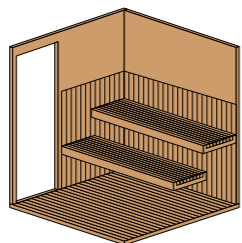

ASPEN
TERMOTRATTATO ASPEN
TERMOTRATTATO (DOGHE)

DECK (OPTIONAL)

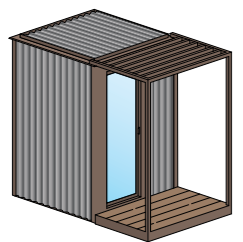

ALLUMINIO COLOR
"WALNUT" PIATTAFORME IN WPC

TENDE (OPTIONAL)



TORTORA

CABANON
GARDEN





CABANON GARDEN
+ DECK MEDIUM
COLOR: MUSCHIO

CABANON
GARDEN



STUFA COORDINATA
CON IL COLORE DELLA
FINITURA ESTERNA



CABANON
GARDEN



DOCCEA ESTERNA,
GANCIO IN METALLO
VERNICIATO (NOCE)



CABANON TERRACE
+ DECK SMALL
COLORE: MATTONE

CABANON
TERRACE



CABANON GARDEN
+ DECK LARGE
COLORE: MUSCHIO



CABANON TERRACE
+ DECK SMALL
COLORE: CEMENTO

CABANON
TERRACE



CABANON TERRACE + DECK SMALL
TENDE COLOR TORTORA (OPTIONAL)

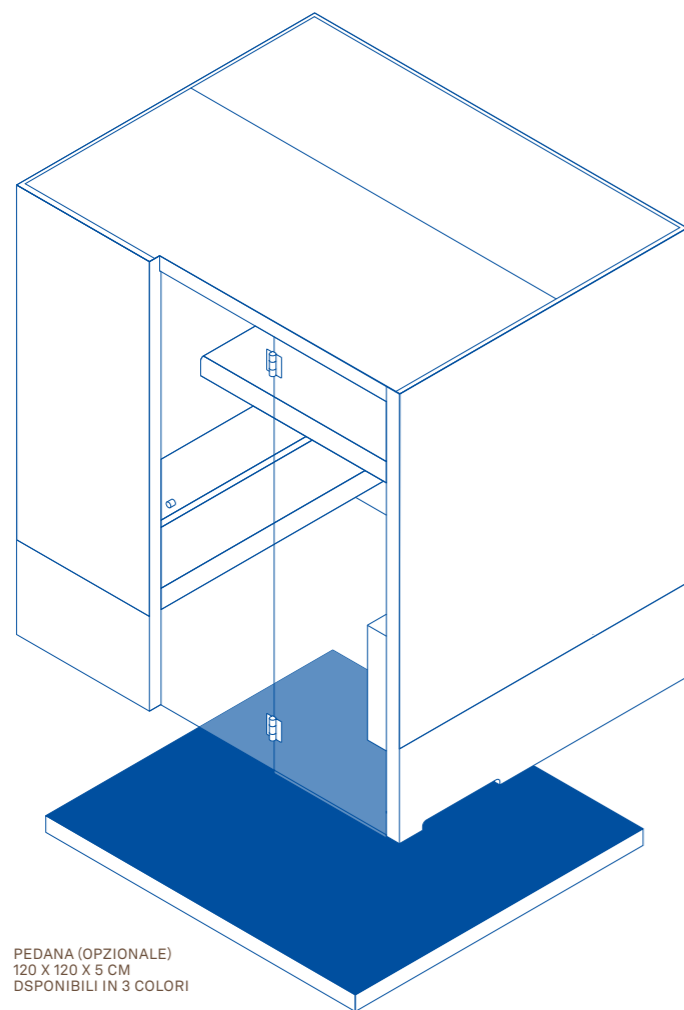

PEDANA (OPZIONALE)
120 X 120 X 5 CM
DISPONIBILI IN 3 COLORI

POTENZA ASSORBITA
4,5 – 6 KW MAX
230VAC 1N 50-60HZ
400VAC 3N 50-60HZ

CONTROLLO REMOTO
GESTIONE A DISTANZA DEL PRODOTTO
TRAMITE APP MY EFFE

MATERIALI
> INTERNO/ESTERNO/ARREDI:
ROVERE RIGATINO /
WENGE RIGATINO
> VETRO TEMPERATO 10 MM
> SPECCHI
> ALLUMINIO ANODIZZATO

Aladdin

Design:
Rodolfo Dordoni, Michele Angelini

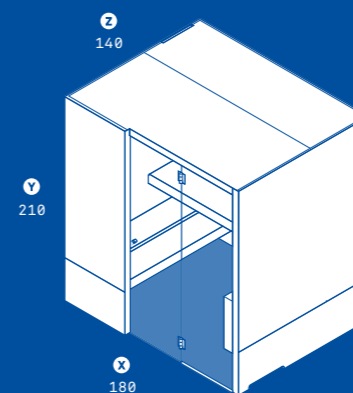

ALADDIN 45

SAUNA

X Z Y
180 x 140 x 210

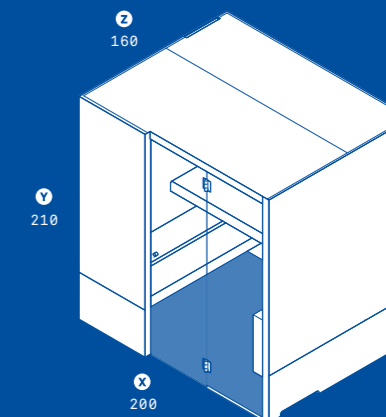

ALADDIN 60

SAUNA

X Z Y
200 x 160 x 210

Con il progetto di Aladdin, Rodolfo Dordoni ha dato vita ad un oggetto iconico dove materiali ricercati e lavorazioni perfette si armonizzano per ridefinire il concetto di sauna. Le pareti lisce si abbinano a panche dalle forme morbide, mentre la parte inferiore, rivestita di specchi, crea un effetto visivo di profondità e leggerezza. Dettagli curati, come la pedana opzionale in grès e la stufa con cover in alluminio anodizzato, esaltano l'eleganza del progetto.

ALADDIN ROVERE

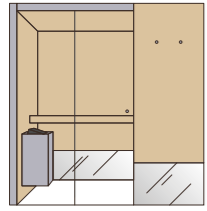

ROVERE
RIGATINO

SPECCHIO

ALLUMINIO
ANODIZZATO

ALADDIN WENGÉ

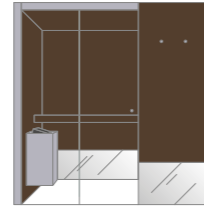

WENGÉ
RIGATINO

SPECCHIO

ALLUMINIO
ANODIZZATO

OPTIONAL

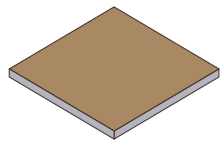

MASTERPIECE
SIENA
GRES PORCELLANATO

ALLUMINIO
ANODIZZATO

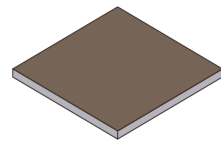

MASTERPIECE
MOKA
GRES PORCELLANATO

ALLUMINIO
ANODIZZATO

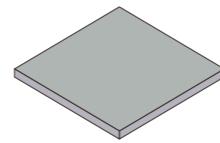

MASTERPIECE
LIGHT
GRES PORCELLANATO

ALLUMINIO
ANODIZZATO

ALADDIN ROVERE





PEDANA IN GRES
PORCELLANATO
CM 120 X 120 X 5 H

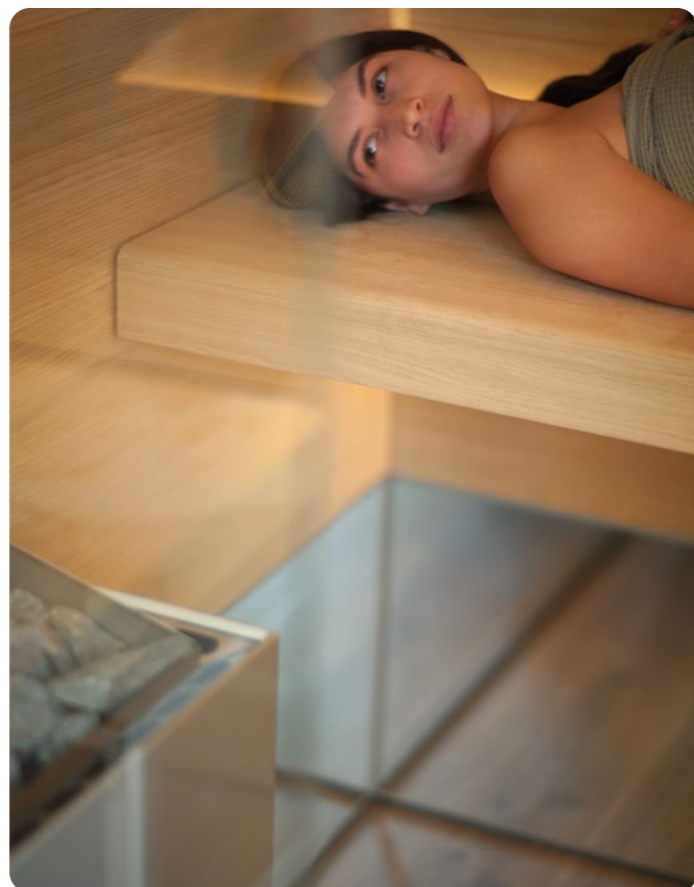

LO SPECCHIO CREA
UN GIOCO VISIVO CHE SEMBRA
FAR FLUTTUARE LA SAUNA

PROFILI DI FINITURA IN ALLUMINIO
ANODIZZATO SU TESTATE,
PARETI E SPESSORE CIELO



ALADDIN
ROVERE



ALADDIN
WENGE



ALADDIN
WENGE

ALADDIN
ROVERE



LE PANCHE HANNO MORBIDI
ANGOLI ARROTONDATI CHE RENDONO
PARTICOLARMENTE PIACEVOLE
IL CONTATTO CON IL LEGNO

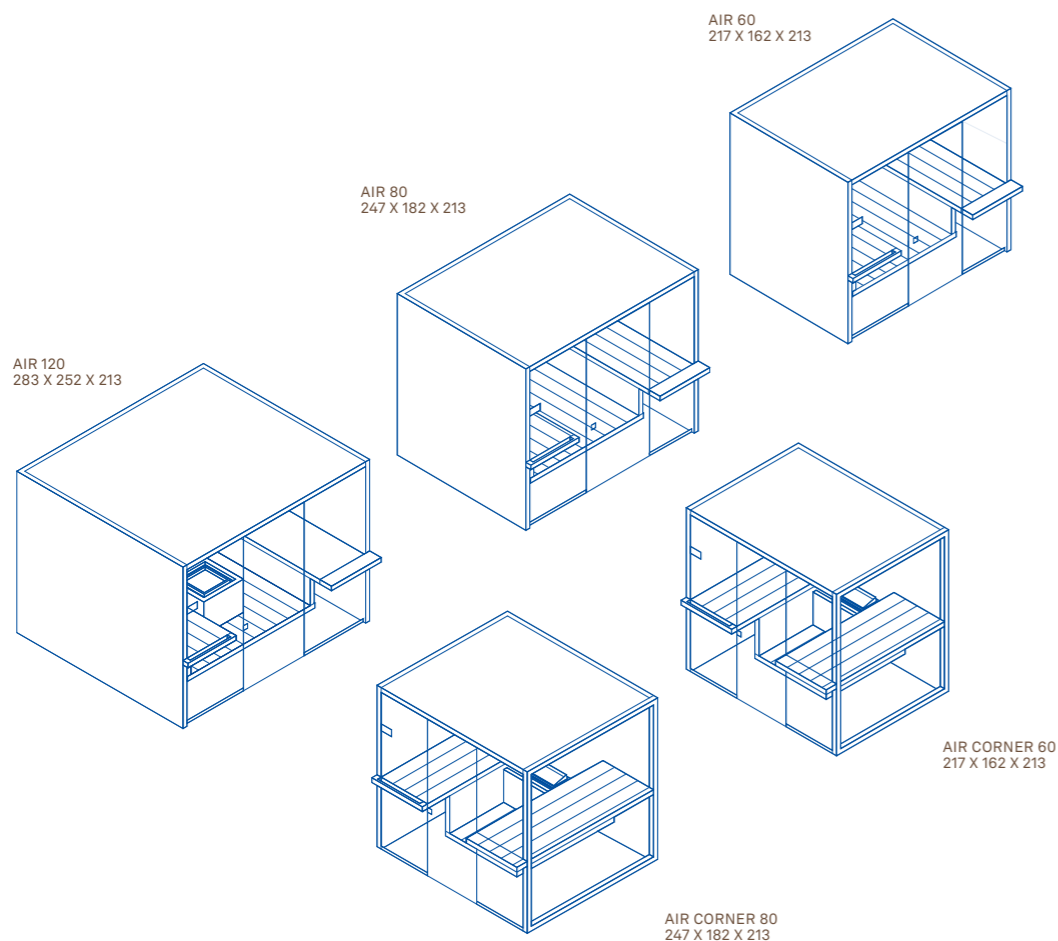

Air

Design:
Giovanna Talocci

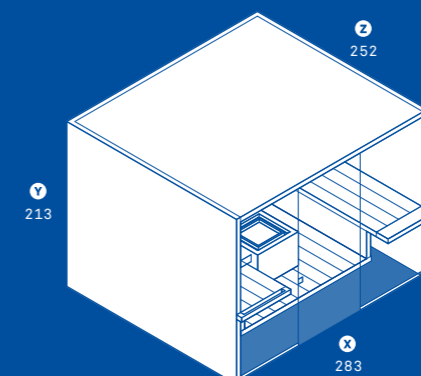

AIR

SAUNA

	X	Z	Y
AIR 120	283	252	213
AIR 80	247	182	213
AIR 60	217	162	213

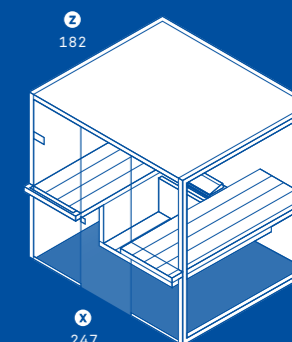

AIR CORNER

SAUNA

	X	Z	Y
AIR CORNER 80	247	182	213
AIR CORNER 60	217	162	213



Una biosauna è una sauna la cui temperatura varia dai 50 ai 60°C con un'umidità del 60-70%. La biosauna può essere applicata a tutte le saune Effe.

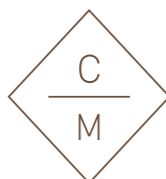

Possibilità di realizzazione con dimensioni su misura.

POTENZA ASSORBITA
 6 – 12 KW MAX
 230VAC 1N 50-60HZ
 400VAC 3N 50-60HZ

POTENZA ASSORBITA BIOSAUNA
 6 – 12 KW MAX
 400VAC 3N 50-60HZ

CONTROLLO REMOTO
 GESTIONE A DISTANZA DEL PRODOTTO
 TRAMITE APP MY EFFE

MATERIALI
 > ESTERNO/INTERNO/ARREDI:
 ASPEN NATURALE /
 ASPEN TERMOTRATTATO
 > VETRI TEMPERATI CHIARI 10 MM

Air è una sauna dal design originale e contemporaneo, caratterizzata dalla sospensione delle sedute e dalla simmetria delle linee, con la stufa in posizione centrale: la leggerezza è il suo il carattere dominante. Nella versione Air 120 la posizione delle panche intorno alla stufa favorisce la convivialità, richiamando il concetto tradizionale di sauna. L'ampia vetrata in cristallo temperato da 10 mm rende la luce un elemento di design del prodotto, amplificando il senso di apertura e benessere.

AIR

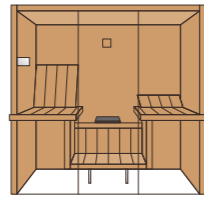
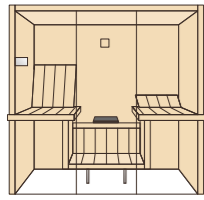

ASPEN NATURALE



ASPEN TERMOTRATTATO

AIR CORNER

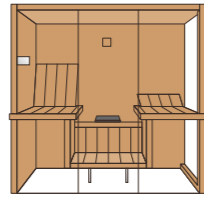
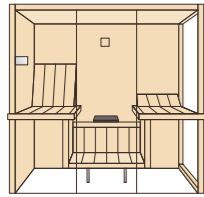

ASPEN NATURALE



ASPEN TERMOTRATTATO



AIR 120
ASPEN TERMOTRATTATO



AIR CORNER 80
ASPEN NATURALE



AIR CORNER.
LE PANCHE SPORGONO ALL'ESTERNO
CREANDO UN PRATICO PORTA ASCIUGAMANI
E UNA MENSOLE

AIR
CORNER



L'AMPIA VETRATA A TUTTA ALTEZZA
È PENSATA PER DISSOLVERE IL CONFINE
TRA PRODOTTO E AMBIENTE CIRCOSTANTE
E PER AVERE GRANDE LUMINOSITÀ ALL'INTERNO

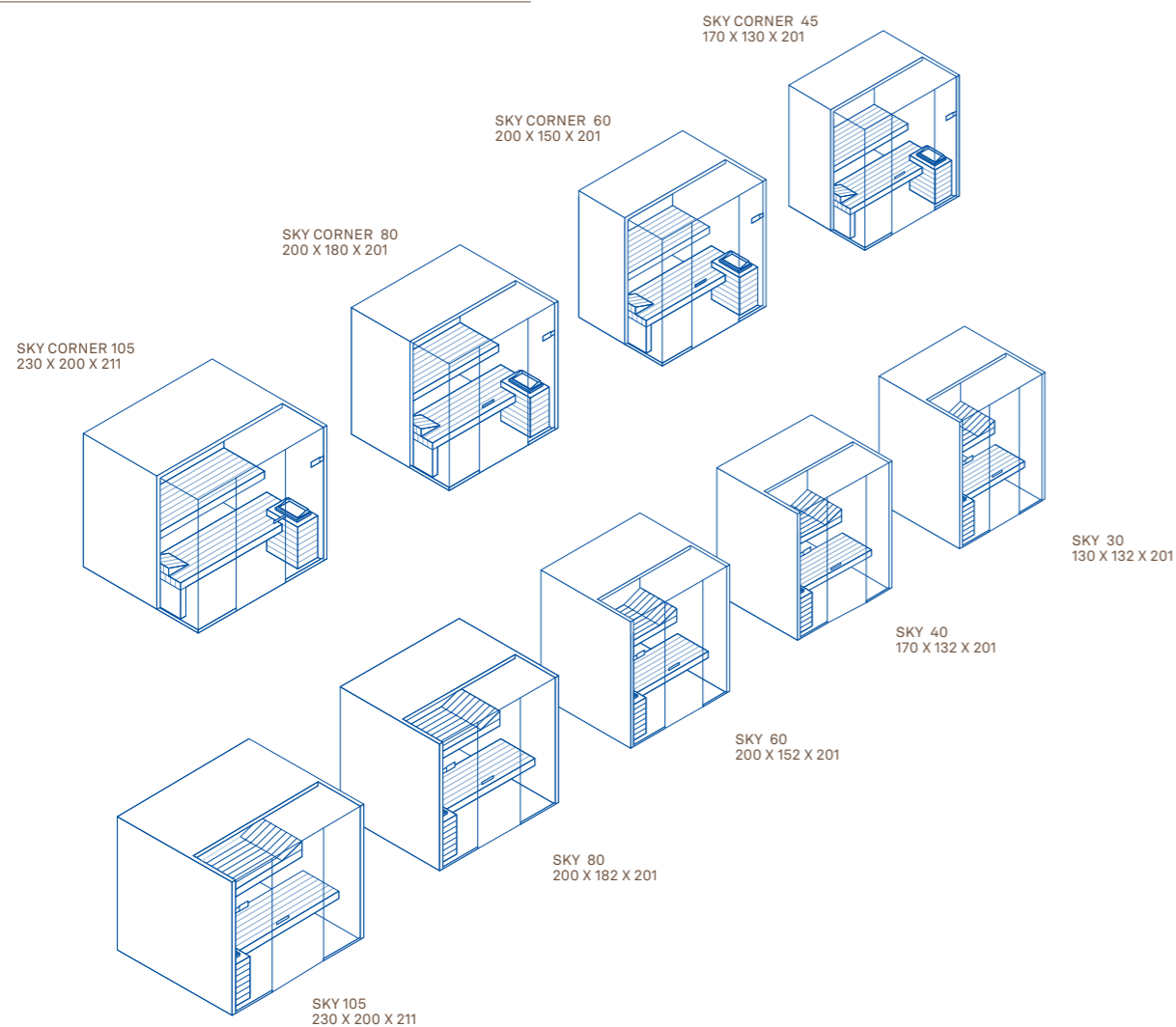

Sky

Design:
Giovanna Talocci

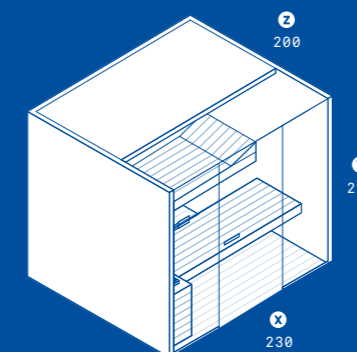

SKY

SAUNA

	X	Z	Y
SKY 105	230	200	211
SKY 80	200	182	201
SKY 60	200	152	201
SKY 40	170	132	201
SKY 30	130	132	201

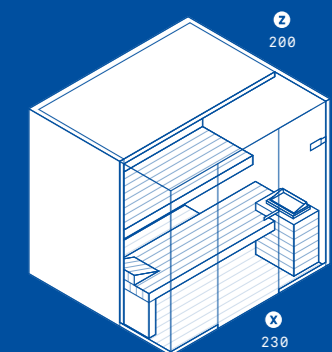

SKY CORNER

SAUNA

	X	Z	Y
SKY CORNER 105	230	200	211
SKY CORNER 80	200	180	201
SKY CORNER 60	200	150	201
SKY CORNER 45	170	130	201



Una biosauna è una sauna la cui temperatura varia dai 50 ai 60°C con un'umidità del 60-70%. La biosauna può essere applicata a tutte le saune Effe.



Possibilità di realizzazione con dimensioni su misura.

POTENZA ASSORBITA
3 – 10,5 KW MAX
230VAC 1N 50-60HZ
400VAC 3N 50-60HZ

POTENZA ASSORBITA BIOSAUNA
3 – 12 KW MAX
400VAC 3N 50-60HZ

CONTROLLO REMOTO
GESTIONE A DISTANZA DEL PRODOTTO
TRAMITE APP MY EFFE

MATERIALI
> ESTERNO/INTERNO/ARREDI:
HEMLOCK CANADESE /
ASPEN TERMOTRATTATO
> VETRI TEMPERATI CHIARI 10 MM

Sky e Sky Corner annullano il confine tra prodotto e ambiente circostante: la luce filtra attraverso le larghe superfici vetrate rendendo unica l'esperienza della sauna. Il perfetto equilibrio raggiunto dalla designer Giovanna Talocci tra tradizione e modernità permette l'inserimento di questo prodotto anche nella zona living, trasformandolo in oggetto di arredo razionale ed elegante.

SKY

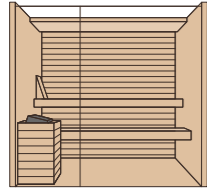

HEMLOCK CANADESE

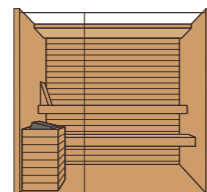

ASPEN TERMOTRATTATO

HEMLOCK CANADESE (DOGHE)

ASPEN TERMOTRATTATO (DOGHE)

SKY CORNER

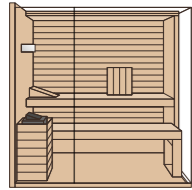

HEMLOCK CANADESE



ASPEN TERMOTRATTATO

HEMLOCK CANADESE (DOGHE)

ASPEN TERMOTRATTATO (DOGHE)



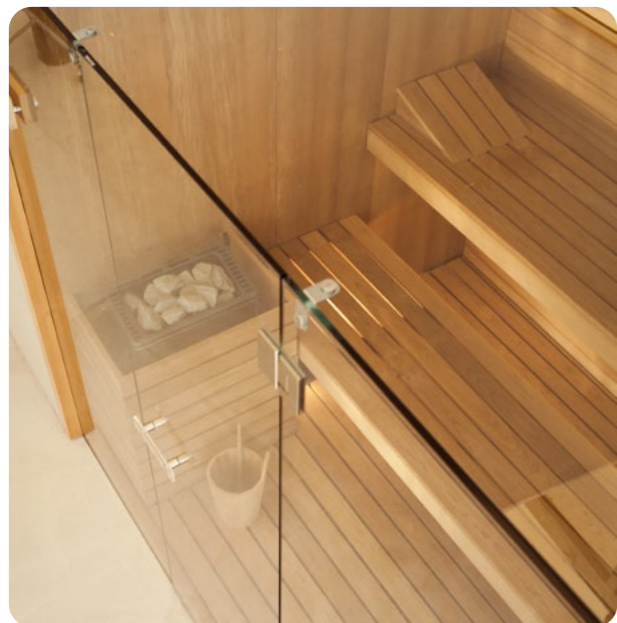

SKY
ASPEN TERMOTRATTATO



SKY CORNER
HEMLOCK CANADESE



SKY

SKY
ASPEN TERMOTRATTATO



SKY
CORNER

SKY CORNER
HEMLOCK CANADESE

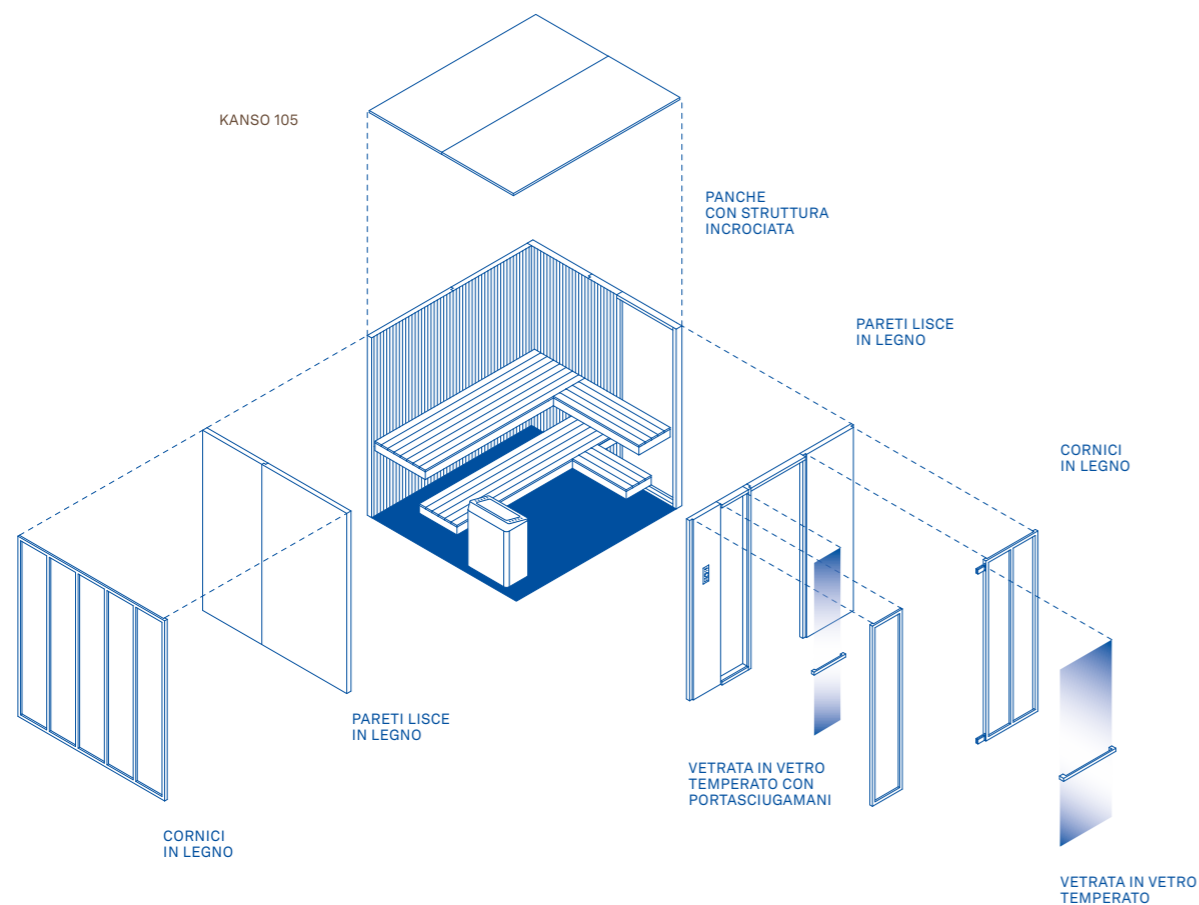

Una biosauna è una sauna la cui temperatura varia dai 50 ai 60°C con un'umidità del 60-70%. La biosauna può essere applicata a tutte le saune Effe.

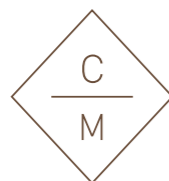

Possibilità di realizzazione con dimensioni su misura.

POTENZA ASSORBITA
 4 – 10,5 KW MAX
 230VAC 1N 50-60HZ
 400VAC 3N 50-60HZ

POTENZA ASSORBITA BIOSAUNA
 4,5 – 12 KW MAX
 400VAC 3N 50-60HZ

CONTROLLO REMOTO
 GESTIONE A DISTANZA DEL PRODOTTO
 TRAMITE APP MY EFFE

MATERIALI
 > INTERNO/ESTERNO/ARREDI:
 ASPEN TERMOTRATTATO
 > VETRI TEMPERATI 8 MM

Kanso

Design:
 Alessandro Andreucci,
 Christian Hoisl

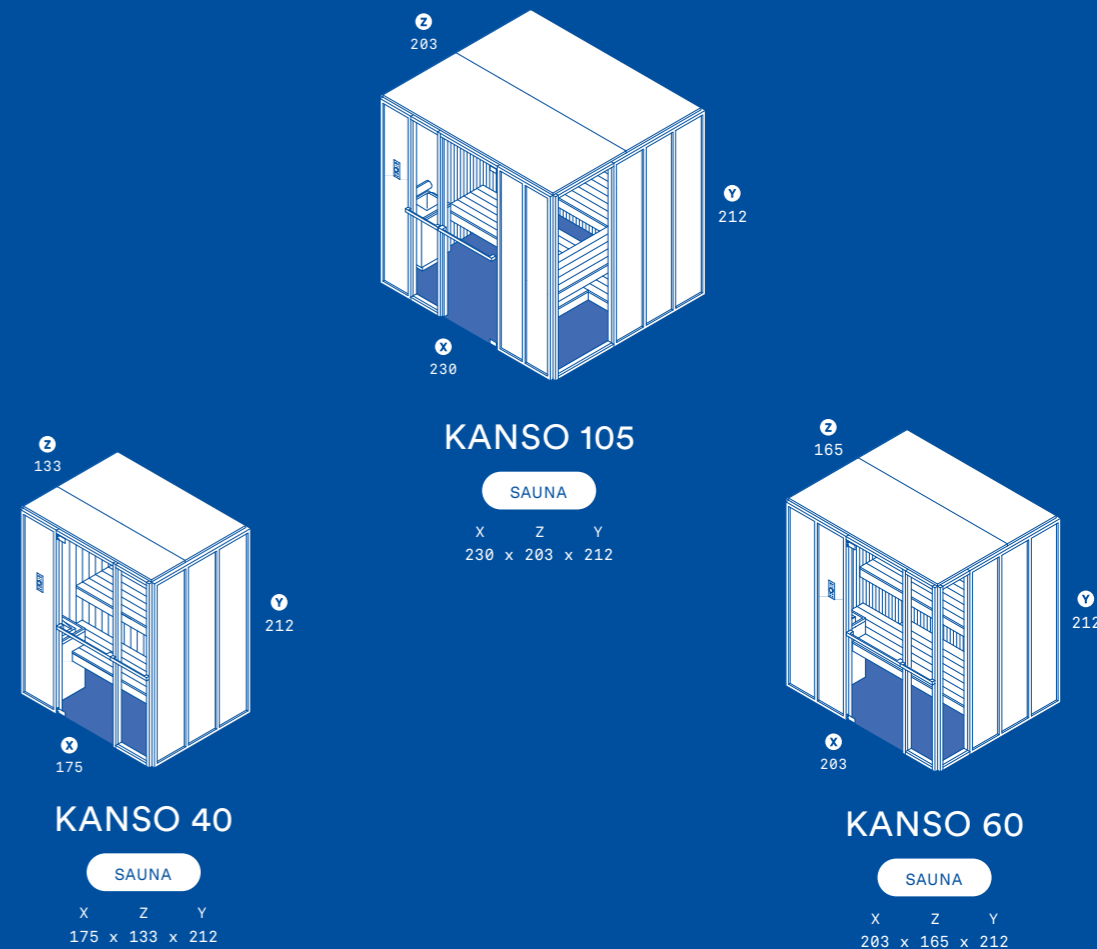

La linea di saune Kanso (dal giapponese “semplicità-purezza”) è caratterizzata da un design ritmico e modulare capace di infondere un senso di tranquillità immediata. Le cornici che scandiscono le pareti danno vita a un'estetica leggera e coordinata, che si fonde perfettamente con il calore del legno di Aspen e dei legni termotrattati. Realizzata con materiali naturali e con processi attenti all'impatto ambientale, Kanso è l'espressione di uno stile di vita sostenibile.

KANSO 105



ASPEN
TERMOTRATTATO

KANSO 60



ASPEN
TERMOTRATTATO

KANSO 40



ASPEN
TERMOTRATTATO





KANSO 60.
ASPEN TERMOTRATTATO
VETRI TEMPERATI DA 8 MM

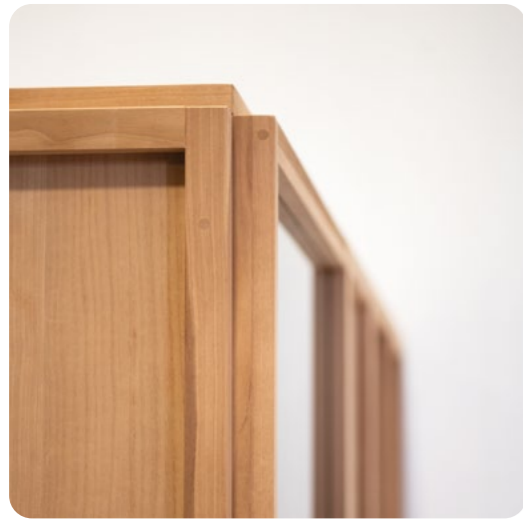

KANSO 105.
PANCHE ASPEN TERMOTRATTATO
CON IL SUO PARTICOLARE
DISEGNO INCROCIATO



SCHIENALE CON LUCE LED
SUPERIORE E INFERIORE
INTEGRATA





KANSO 105
ASPEN TERMOTRATTATO



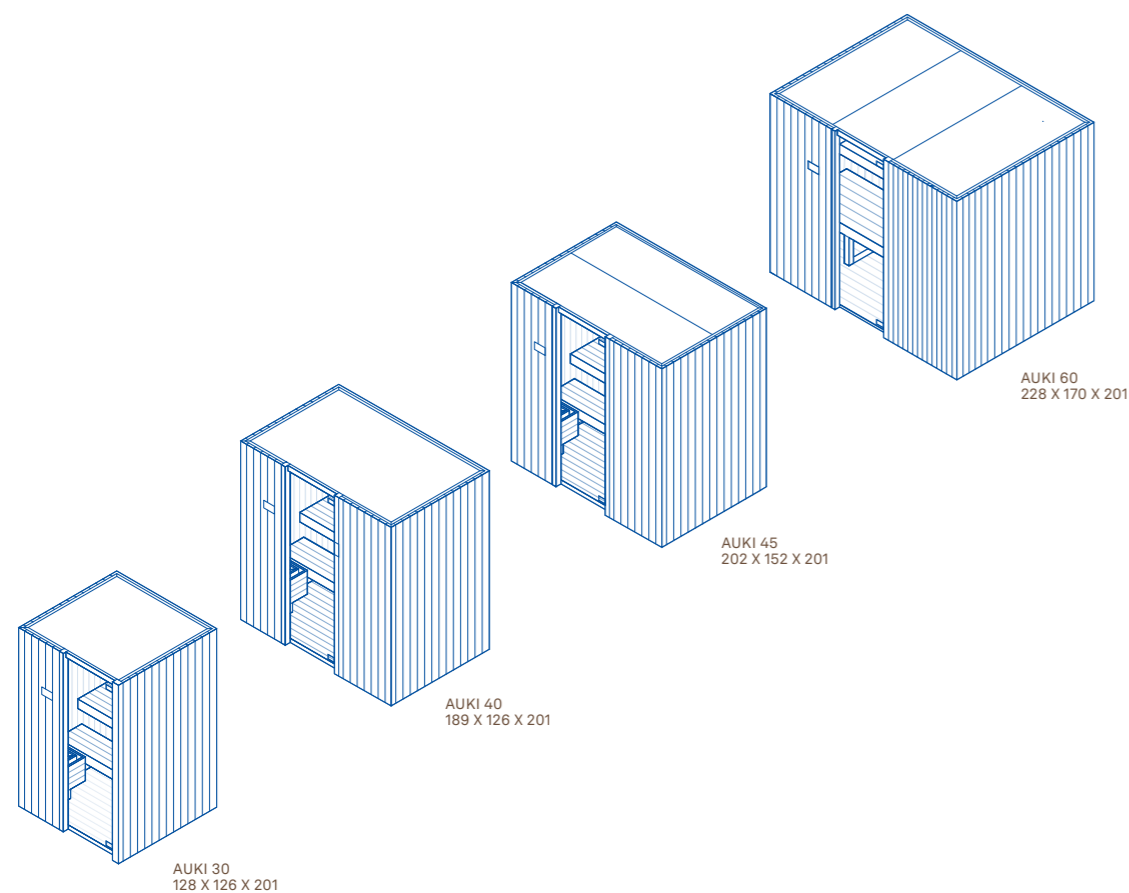

Auki

Design:
Giovanna Talocci

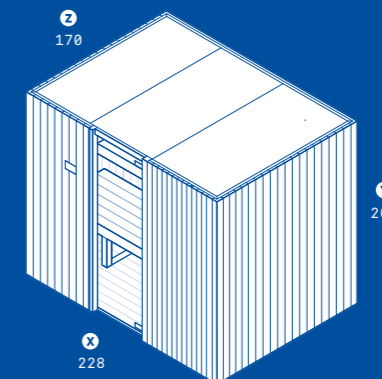

SAUNA

	X	Z	Y
AUKI 60	228 x	170 x	201
AUKI 45	202 x	152 x	201
AUKI 40	189 x	126 x	201
AUKI 30	128 x	126 x	201



Una biosauna è una sauna la cui temperatura varia dai 50 ai 60°C con un'umidità del 60-70%. La biosauna può essere applicata a tutte le saune Effe.

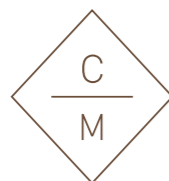

Possibilità di realizzazione con dimensioni su misura.

POTENZA ASSORBITA
 3 – 6 KW MAX
 230VAC 1N 50-60HZ
 400VAC 3N 50-60HZ

POTENZA ASSORBITA BIOSAUNA
 3 – 6 KW MAX
 230VAC 1N 50-60HZ
 400VAC 3N 50-60HZ

CONTROLLO REMOTO
 GESTIONE A DISTANZA DEL PRODOTTO
 TRAMITE APP MY EFFE

MATERIALI
 > ESTERNO/INTERNO/ARREDAMENTI:
 ABETE DI SVEZIA/
 HEMLOCK CANADESE /
 ASPEN TERMOTRATTATO
 > VETRI TEMPERATI CHIARI 8 MM

Auki è un omaggio alla tradizione nordica. La purezza del rito classico è esaltata dal senso di intimità delle larghe superfici in legno, dalla verticalità marcata dalle doghe, il rivestimento disponibile anche in Abete con nodi a vista. Auki coniuga elementi di design innovativi come la maniglia che scompare perché inclusa nella parete frontale, le vetrate a tutta altezza, il quadro comandi in acciaio spazzolato.

AUKI

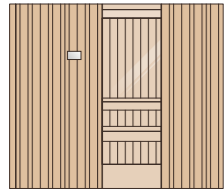

HEMLOCK CANADESE

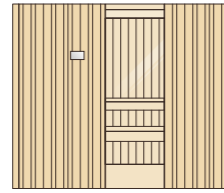

ABETE DI SVEZIA

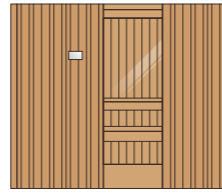

ASPEN TERMOTRATTATO

OPTIONAL

VETRATA FRONTALE (NON DISPONIBILE PER AUKI 30)



HEMLOCK CANADESE

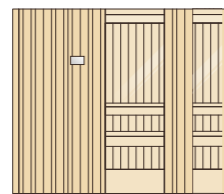

ABETE DI SVEZIA

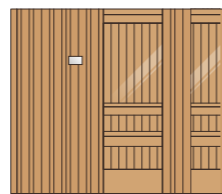

ASPEN TERMOTRATTATO

AUKI
HEMLOCK CANADESE

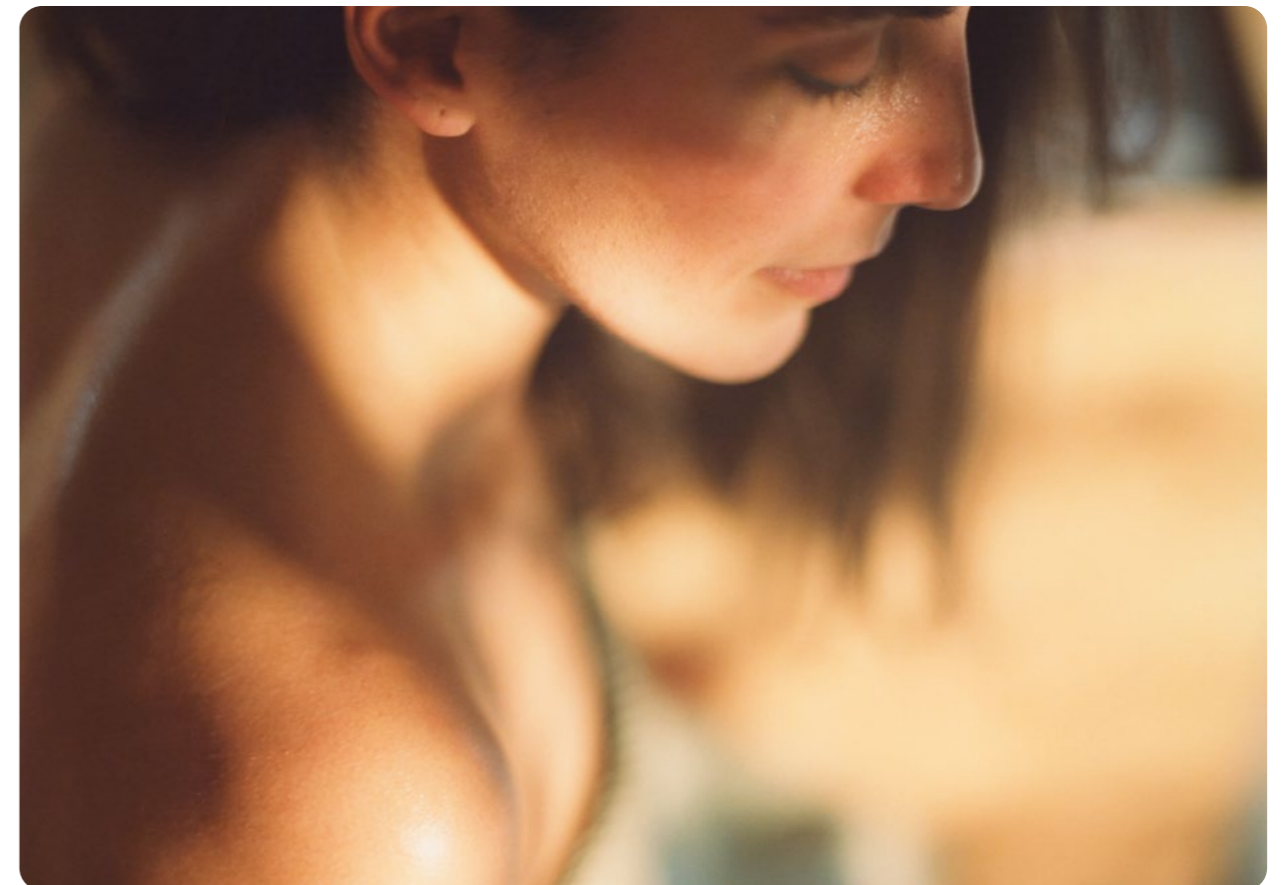



AUKI
ABETE SVEDESE
VETRATA FRONTALE OPZIONALE

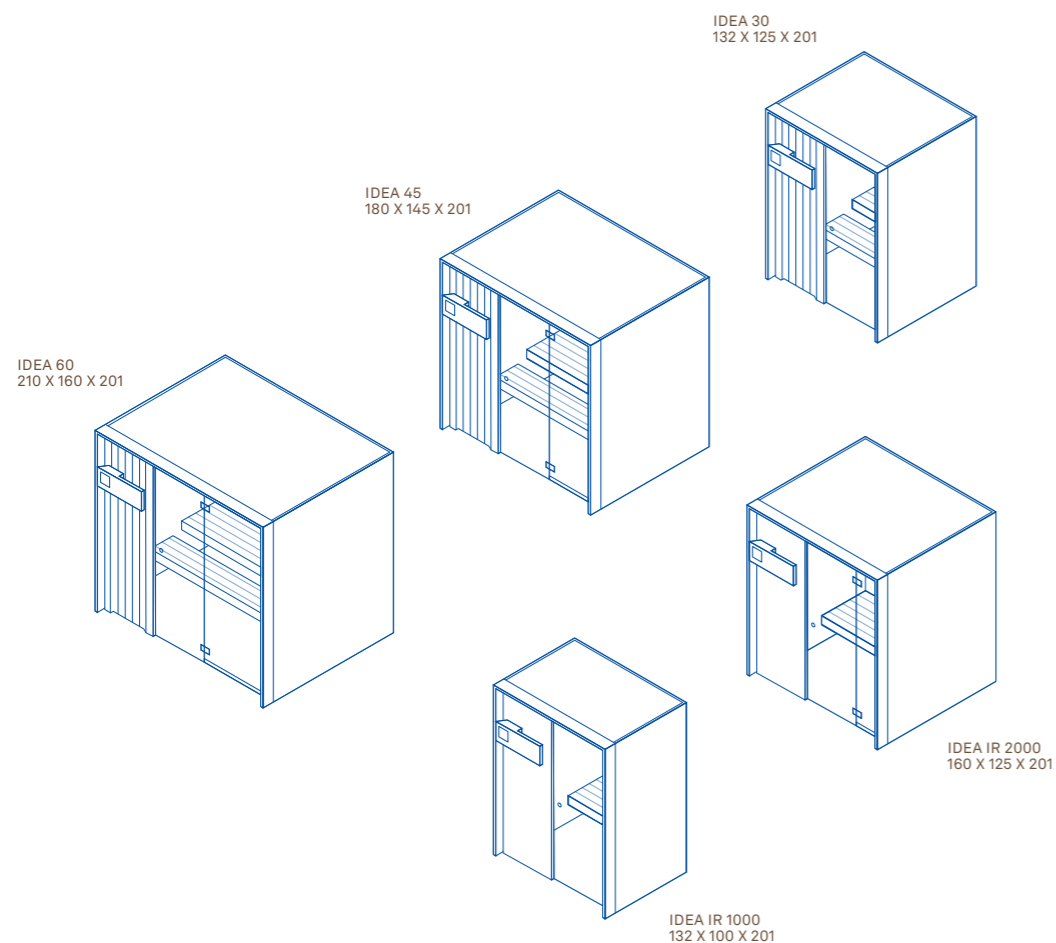

POTENZA ASSORBITA
3 – 6 KW MAX
230VAC 1N 50-60HZ
400VAC 3N 50-60HZ

POTENZA ASSORBITA INFRAROSSI
2 KW MAX
230VAC 1N 50-60HZ
4 EMETTITORI AD IR A LARGO SPETTRO
DI POTENZA, 500 W CADAUNO

CONTROLLO REMOTO
GESTIONE A DISTANZA DEL PRODOTTO
TRAMITE APP MY EFFE

MATERIALI
> ESTERNO/INTERNO/ARREDAMENTI:
ABETE /
ASPEN TERMOTRATTATO
> VETRI TEMPERATI CHIARI 8 MM

Idea

Design:
Giovanna Talocci

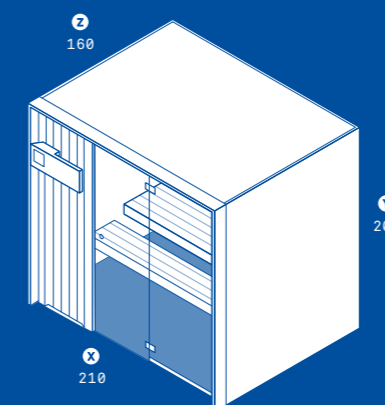

IDEA

SAUNA

	X	Z	Y
IDEA 60	210	160	201
IDEA 45	180	145	201
IDEA 30	132	125	201

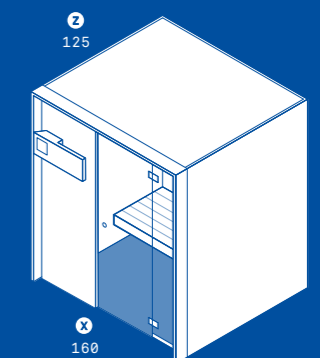

IDEA IR

INFRAROSSI

	X	Z	Y
IDEA IR 2000	160	125	201
IDEA IR 1000	132	100	201

Idea è la collezione firmata Giovanna Talocci che comprende sauna e cabina in infrarossi. Linee pulite, richiami alla tradizione nordica e dettagli ricercati caratterizzano un prodotto dal design classico e dall'appeal contemporaneo. La cornice esterna con imbottito inclinato conferisce profondità ai prodotti della collezione, anche nelle dimensioni più ridotte.

IDEA

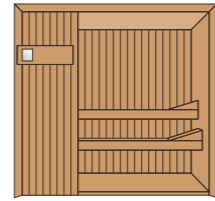
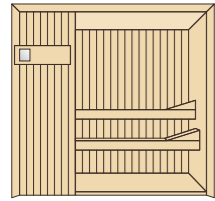

ABETE DI SVEZIA

ASPEN TERMOTRATTATO

IDEA IR

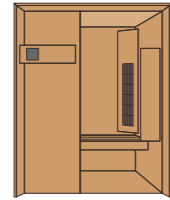
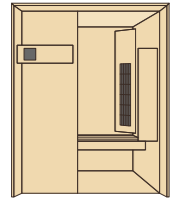

ABETE DI SVEZIA

ASPEN TERMOTRATTATO

ASPEN
TERMOTRATTATO



IDEA
SAUNA

ASPEN
TERMOTRATTATO



IDEA IR
INFRAROSSI



PORTASCUGAMANI E PANNELLO
DI CONTROLLO IN ACCIAIO SPAZZOLATO

CORNICE ESTERNA CON IMBOTTITO INCLINATO
CHE CONFERISCE PROFONDITÀ ANCHE
NELLE DIMENSIONI PIÙ RIDOTTE



INFRAROSSO: INDICATO PER
TRATTAMENTO LESIONI SPORTIVE
E ALLEVIA I DOLORI MUSCOLARI





Vapore

Acqua

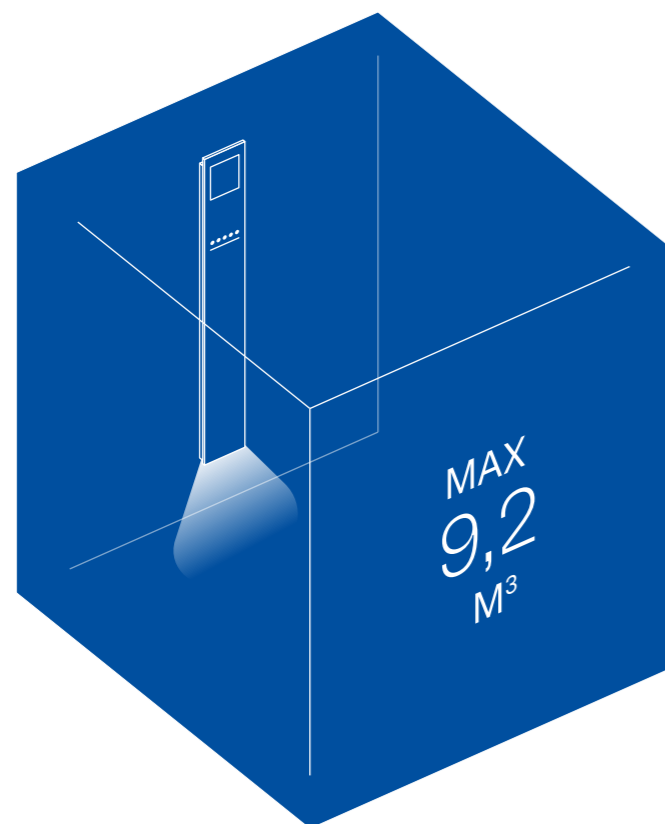

MAX
9,2
M³

IN AMBIENTE COIBENTATO
CON KIT ISOLANTE
SPESSORE 3 CM



EFFE SOUND
SYSTEM



PERFETTA
DENSITÀ DEL VAPORE



INTERVENTI
DI MANUTENZIONE
RIDOTTI



CONSUMI
OTTIMIZZATI



FACILE
DA INSTALLARE



CONTROLLO REMOTO
TRAMITE APP

POTENZA ASSORBITA
4,5 – 9 KW MAX
230VAC 1N 50-60HZ
400VAC 3N 50-60HZ

MATERIALI
VETRO TEMPERATO SERIGRAFATO
ALLUMINIO VERNICIATO RAL 9003

FUNZIONE POWER STEAM
SISTEMA DI DIFFUSIONE VAPORE
A VENTILAZIONE FORZATA

GENERATORE DI VAPORE INTERNO
CARATTERISTICHE

- > SISTEMA AUTOMATICO DI LAVAGGIO CALDAIA
- > SISTEMA DI REGOLAZIONE PORTATA ACQUA
- > SISTEMA AUTOMATICO DI SCARICO ACQUA
- > FUNZIONE ENERGY SAVER AUTOMATICA

PANNELLO DI CONTROLLO TOUCH
CON ICONE RETROILLUMINATE E
INDICATORE DEL LIVELLO DI
TEMPERATURA

ILLUMINAZIONE
CON CROMOTERAPIA
A LED RGB 5 COLORI FISSI, 4 CICLI
DINAMICI E LUCE BIANCA

Touch&Steam Smart

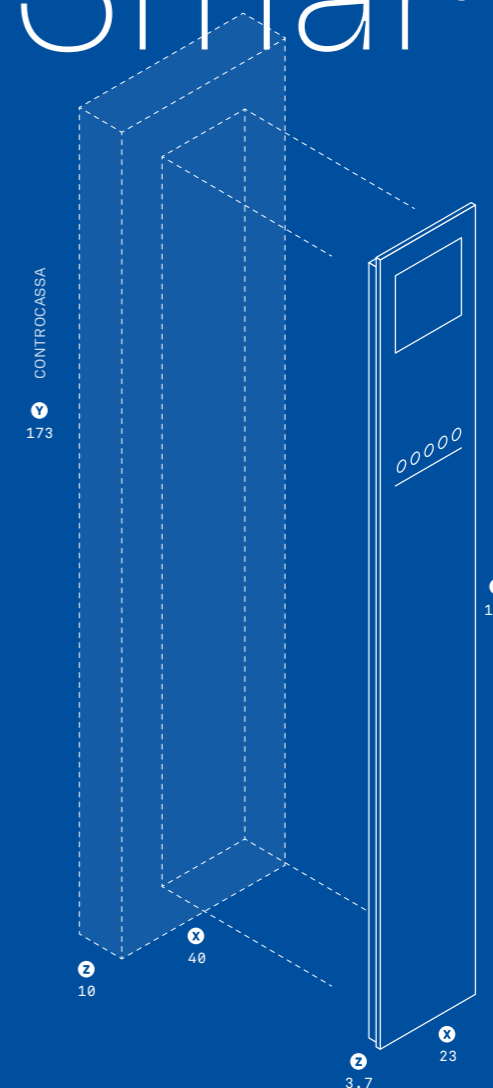

DESIGN
PLUS

MENTIONE
D'ONORE
COMPASSO D'ORO
ADI

Touch&Steam Smart è un generatore di vapore professionale dal design elegante e compatto, la cui unica parte visibile è una semplice lastra di vetro temperato serigrafato con uno spessore totale di soli 3,7 cm. Versatile e semplice da utilizzare, si adatta facilmente a qualsiasi hammam, dalla doccia di casa a Spa pubbliche. Include cromoterapia, aromaterapia e diffusione sonora con Effe Sound System. La caldaia incassata garantisce un'installazione rapida e discreta.



TOUCH&STEAM SMART
GENERATORE DI VAPORE
INTERNO

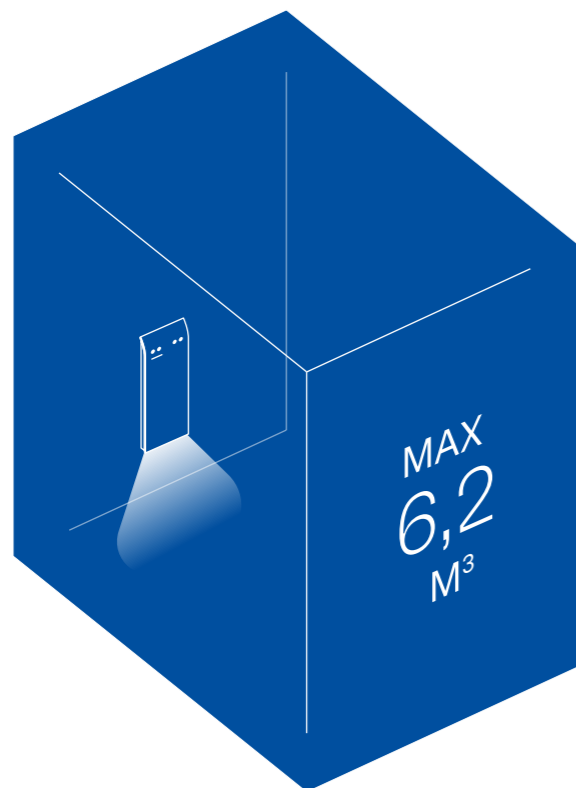

IN AMBIENTE COIBENTATO
CON KIT ISOLANTE
SPESSORE 3 CM

MAX
6,2
M³



PERFETTA
DENSITÀ DEL VAPORE



INTERVENTI
DI MANUTENZIONE
RIDOTTI



CONSUMI
OTTIMIZZATI



FACILE
DA INSTALLARE



CONTROLLO REMOTO
TRAMITE APP

POTENZA ASSORBITA
3 – 6 KW MAX
230VAC 1N 50-60HZ
400VAC 3N 50-60HZ

MATERIALI
VETRO TEMPERATO SERIGRAFATO
ALLUMINIO VERNICIATO RAL 9003

FUNZIONE POWER STEAM
SISTEMA DI DIFFUSIONE VAPORE
A VENTILAZIONE FORZATA

GENERATORE DI VAPORE INTERNO
CARATTERISTICHE

- > SISTEMA AUTOMATICO DI LAVAGGIO CALDAIA
- > SISTEMA DI REGOLAZIONE PORTATA ACQUA
- > SISTEMA AUTOMATICO DI SCARICO ACQUA
- > FUNZIONE ENERGY SAVER AUTOMATICA

PANNELLO DI CONTROLLO TOUCH
CON ICONE RETROILLUMINATE E
INDICATORE DEL LIVELLO DI
TEMPERATURA

ILLUMINAZIONE
CON CROMOTERAPIA A LED RGB
5 COLORI FISSI, 4 CICLI DINAMICI E
LUCE BIANCA

Easystem Smart

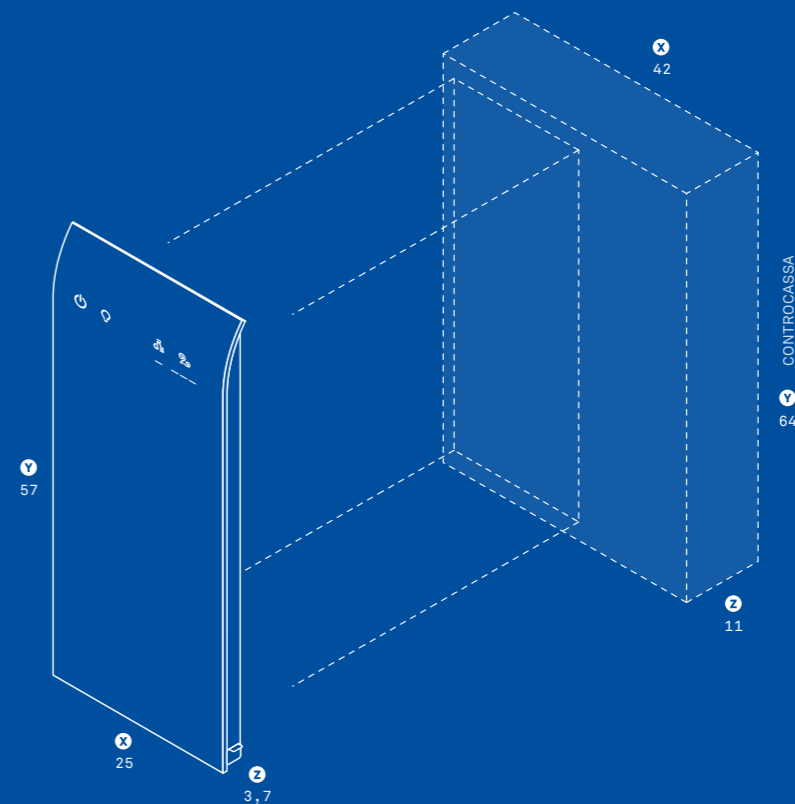

Easystem Smart è un generatore di vapore elegante e compatto, che coniuga facilità d'installazione, tecnologia avanzata e praticità d'uso. Questo generatore può essere installato anche all'interno della cabina doccia, trasformandola così in un autentico hammam privato. Grazie alla tecnologia Effe, offre un vapore di qualità superiore, garantendo igiene e controllo del calcare. La manutenzione è minima, poiché il sistema automatico di lavaggio della caldaia limita l'accumulo di calcare, assicurando lunga durata.



EASYTEAM SMART
GENERATORE DI VAPORE
INTERNO

IL PANNELLO DI CONTROLLO IN
VETRO RETROILLUMINATO PUO'
ESSERE INSERITO INTERNAMENTE
O ESTERNAMENTE AL VANO
HAMMAM (OPZIONALE)



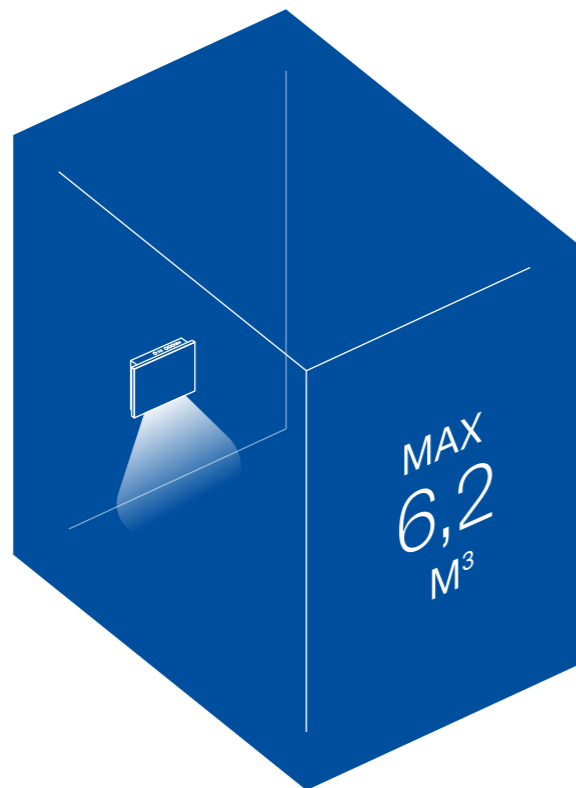

IN AMBIENTE COIBENTATO
CON KIT ISOLANTE
SPESSORE 3 CM

Inside

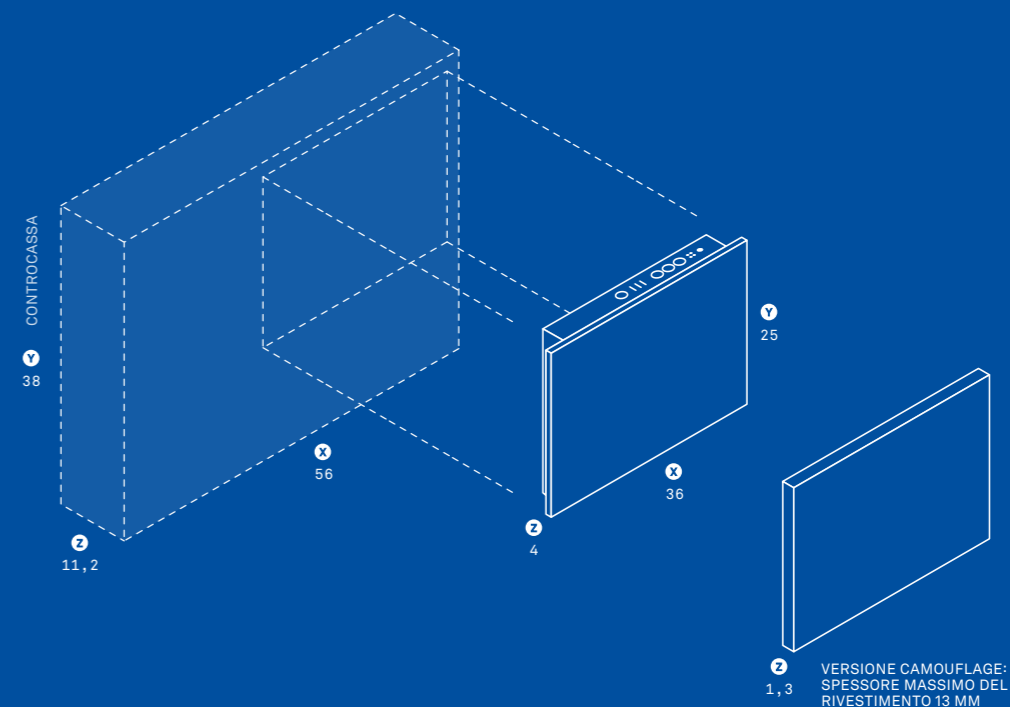

PERFETTA
DENSITÀ DEL VAPORE



INTERVENTI
DI MANUTENZIONE
RIDOTTI



CONSUMI
OTTIMIZZATI



FACILE
DA INSTALLARE



CONTROLLO REMOTO
TRAMITE APP

POTENZA ASSORBITA
3 – 6 KW MAX
230VAC 1N 50-60HZ
400VAC 3N 50-60HZ

MATERIALI
> VETRO SERIGRAFATO (GLASS)
> ACCIAIO INOX FINITURA SATINATA
RIVESTIBILE, SPESSORE MAX DEL
RIVESTIMENTO, COLLA INCLUSA,
13 MM (CAMOUFLAGE)

FUNZIONE POWER STEAM
SISTEMA DI DIFFUSIONE VAPORE A
VENTILAZIONE FORZATA

GENERATORE DI VAPORE INTERNO
CARATTERISTICHE

- > SISTEMA AUTOMATICO DI LAVAGGIO CALDAIA
- > SISTEMA DI REGOLAZIONE PORTATA ACQUA
- > SISTEMA AUTOMATICO DI SCARICO ACQUA
- > FUNZIONE ENERGY SAVER AUTOMATICA

PANNELLO DI CONTROLLO INTEGRATO
CON ICONE RETROILLUMINATE E
INDICATORE DEL LIVELLO DI
TEMPERATURA

LUCE LED INTEGRATA
INSIDE È DOTATO DI LUCE LED RGB PER
UN'ESPERIENZA DI
CROMOTERAPIA INTEGRATA

Inside è un generatore di vapore interno nato dall'incontro fra tecnologia, funzionalità ed estetica. La versione Glass è elegante e discreta grazie al pannello in vetro bianco. Può inoltre essere personalizzata nei colori o nella grafica con una stampa in serigrafia. La versione Camouflage permette di incorporare sul fronte la stessa finitura dell'interno hammam, così da nascondere completamente l'erogatore di vapore per ottenere una pulizia formale senza pari.



INSIDE CAMOUFLAGE
GENERATORE DI VAPORE INTERNO
RIVESTIBILE CON IDENTICA
FINITURA DEL VANO HAMMAM
+ CORNICE IN ACCIAIO INOX

INSIDE GLASS
GENERATORE DI VAPORE INTERNO
VETRO PERSONALIZZATO
CON SERIGRAFIA

INSIDE GLASS
GENERATORE DI VAPORE
INTERNO





IN AMBIENTE COIBENTATO
 CON KIT ISOLANTE
 SPESSORE 3 CM

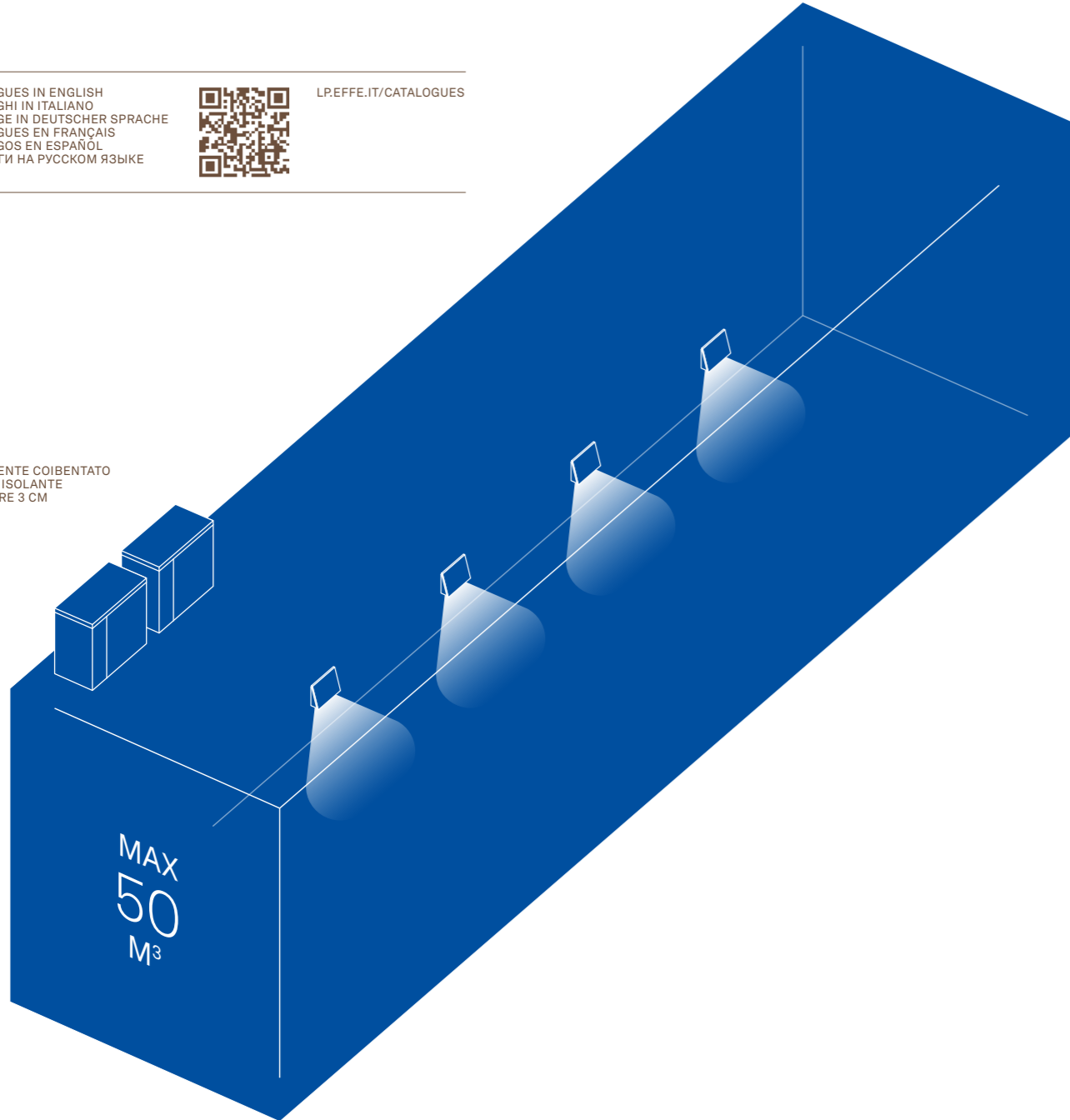

PERFETTA
 DENSITÀ DEL VAPORE



INTERVENTI
 DI MANUTENZIONE
 RIDOTTI



CONSUMI
 OTTIMIZZATI



FACILE
 DA INSTALLARE



CONTROLLO REMOTO
 TRAMITE APP

POTENZA ASSORBITA
 3 – 96 KW MAX
 230VAC 1N 50-60HZ
 400VAC 3N 50-60HZ

DIFFUSORE DI VAPORE SMART
 > GLASS: FRONTALE IN VETRO
 > CAMOUFLAGE: FRONTALE
 RIVESTIBILE, SPESSORE MAX
 RIVESTIMENTO 13 MM
 > ALETTE ORIENTABILI PER
 DIREZIONARE IL VAPORE
 > CONTENITORE PER ESSENZE
 > LED LUMINOSO ALL'USCITA DEL
 VAPORE
 > SONDA DI TEMPERATURA
 AGGIUNTIVA

DIFFUSORE DI VAPORE TRADIZIONALE
 > VASCHETTA PORTA ESSENZE
 INTEGRATA

**GENERATORE DI VAPORE ESTERNO
 CARATTERISTICHE**

> SISTEMA AUTOMATICO
 DI LAVAGGIO CALDAIA
 > SISTEMA DI REGOLAZIONE
 PORTATA ACQUA
 > SISTEMA AUTOMATICO
 DI SCARICO ACQUA
 > FUNZIONE ENERGY SAVER
 AUTOMATICA

**FUNZIONE POWER STEAM (DIFFUSORE
 DI VAPORE SMART)**
 SISTEMA DI DIFFUSIONE VAPORE
 A VENTILAZIONE FORZATA

Nuvola Smart

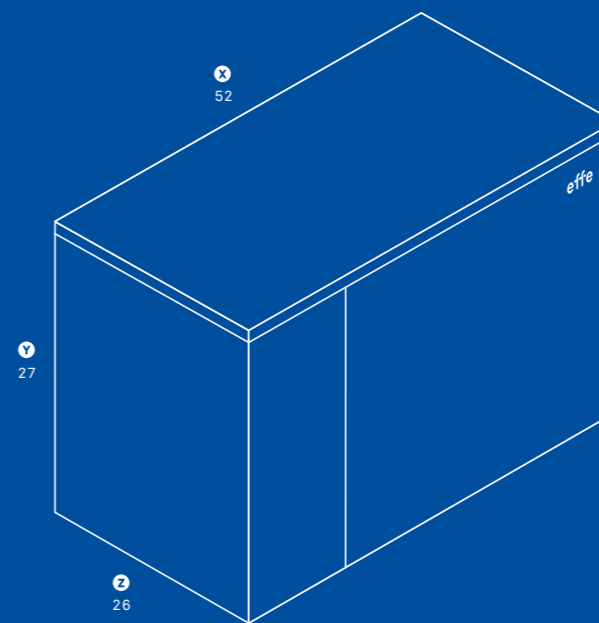

	X	Z	Y
NUVOLA SMART 30	52	26	27
NUVOLA SMART 45	52	26	27
NUVOLA SMART 55	52	26	27
NUVOLA SMART 70	52	26	27
NUVOLA SMART 90	52	26	27
NUVOLA SMART 110	52	26	45
NUVOLA SMART 140	52	26	45
NUVOLA SMART 180	52	26	45
NUVOLA SMART 250	52	26	95
NUVOLA SMART 360	52	26	95



DIFFUSORE
 DI VAPORE
 TRADIZIONALE

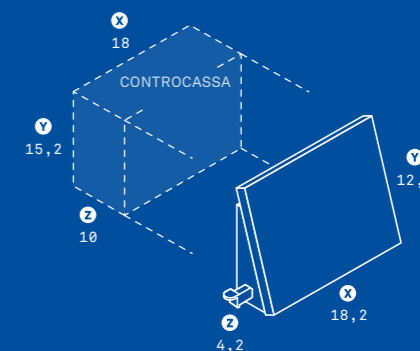

DIFFUSORE DI
 VAPORE SMART

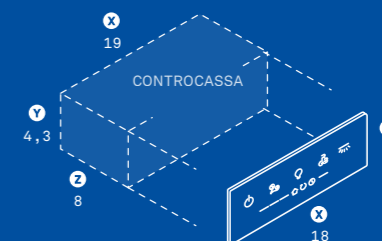

PANNELLO DI
 CONTROLLO

Generatore di vapore ad alta potenza, da collocare all'esterno dello spazio hammam: la più sofisticata tecnologia esistente e la pulizia formale fanno di Nuvola Smart un prodotto senza rivali. Disponibile in 10 varianti di potenza, Nuvola Smart è in grado di coprire un volume che va da 2,5 m³ fino a 50 m³. Il diffusore di vapore Smart, disponibile in versione Glass e Camouflage, si integra facilmente con qualsiasi soluzione d'arredo.



NUVOLA SMART DIFFUSER
LA VERSIONE CAMOUFLAGE È
RIVESTIBILE CON LA STESSA FINITURA
DEL VANO HAMMAM



NUVOLA SMART DIFFUSER
VERSIONE GLASS





DIFFUSORE TRADIZIONALE
PVD MATTE BLACK



WATERDREAM

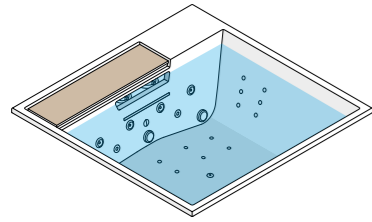

GRES LAMINATO:
SLIMTECH PELT

WATERSUITE

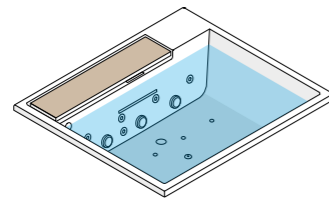

GRES LAMINATO:
SLIMTECH PELT

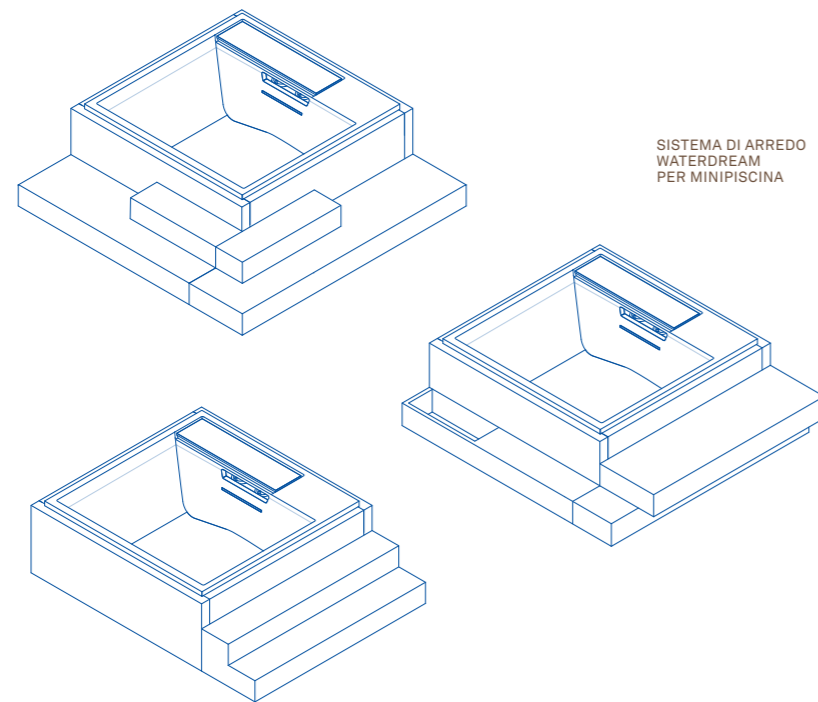

SISTEMA DI ARREDO
WATERDREAM
PER MINIPISCINA

WaterDream WaterSuite

Design:
Giovanna Talocci, Marco Pallocca

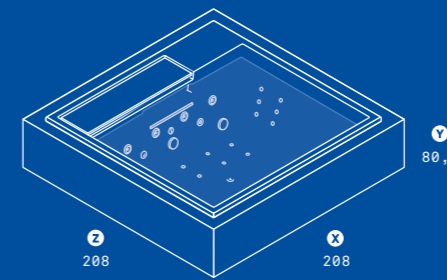

WATERDREAM

MINIPISCINA

X Z Y
208 x 208 x 80,5

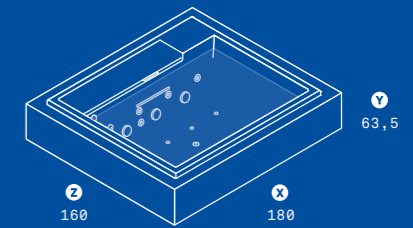

WATERSUITE

VASCA

X Z Y
180 x 160 x 63,5

CATALOGUES IN ENGLISH
CATALOGHI IN ITALIANO
KATALOGE IN DEUTSCHER SPRACHE
CATALOGUES EN FRANÇAIS
CATÁLOGOS EN ESPAÑOL
КАТАЛОГИ НА РУССКОМ ЯЗЫКЕ
目錄



LP.EFFE.IT/CATALOGUES

MATERIALI

- > VASCA IN ACRILICO COLATO (PMMA) CON RINFORZO IN COMPOSITO.
- > PORTELLO VANO COMANDI RIVESTITO IN GRES LAMINATO:SLIMTECH PELT, ILLUMINATO A LED RGB.
- > TELAIO ACCIAIO ZINCATO CON PIEDINI REGOLABILI.

FUNZIONI

WATERDREAM:

- > FUNZIONE BACK MASSAGE 6 + 6 JET
- > FUNZIONE SOURCE - 1 JET INFERIORE
- > FUNZIONE WHIRLPOOL - 8 JET
- > FUNZIONE AIR MILK - 4 JET CON POMPA MULTISTADIO
- > FUNZIONE BLOWER - 16 JET CON ARIA RISCALDATA

WATERSUITE:

- > FUNZIONE SOURCE - 1 JET INFERIORE
- > FUNZIONE WHIRLPOOL - 8 JETS
- > FUNZIONE AIR MILK - 2 JETS CON POMPA MULTISTADIO
- > FUNZIONE BLOWER - 8 JETS CON ARIA RISCALDATA

WaterDream e WaterSuite sono piccole oasi di piacere che completano la tua area benessere privata. Con diverse modalità di idromassaggio e giochi di luce colorata, creano atmosfere rilassanti e piacevoli. In aggiunta ai classici massaggi d'acqua, la funzione Source genera un flusso circolare dal fondo della vasca, avvolgendo in un comfort rigenerante. WaterDream prevede inoltre un sistema di arredo che consente una perfetta integrazione anche in ambienti diversi.



WATERDREAM
MINI PISCINA



WATERDREAM
MINI PISCINA

SENSORY SHOWER



FINITURA
CROMATA



FINITURA
NERA OPACA



FINITURA PVD
GUNMETAL OPACA

CATALOGUES IN ENGLISH
CATALOGHI IN ITALIANO
KATALOGE IN DEUTSCHER SPRACHE
CATALOGUES EN FRANÇAIS
CATÁLOGOS EN ESPAÑOL
КАТАЛОГИ НА РУССКОМ ЯЗЫКЕ
目録



LP.EFFE.IT/CATALOGUES

MATERIALI
PIASTRA IN ACCIAIO INOX
SUPER MIRROR

FUNZIONI
> GETTO PIOGGIA
> GETTO CASCATA
> 2 GETTI NEBULIZZATI
> 4 FARETTI LED CON CROMOTERAPIA
> PROGRAMMA AUTOMATICO

Sensory Shower

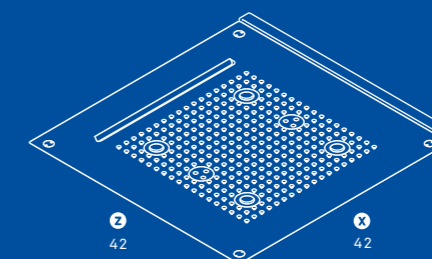

SOFFIONE

X Z
42 x 42

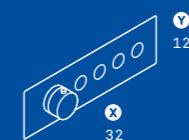

PANNELLO DI CONTROLLO

X Y
32 x 12



AROMATERAPIA



RUBINETTERIA

Doccia multifunzionale e multisensoriale per il vostro spazio benessere. Sensory Shower è completa di cromoterapia, diffusore di aromi (opzionale) e pannello di controllo per la gestione delle funzioni e della temperatura. Il soffione dispone di 2 getti nebulizzati, un getto pioggia e un getto cascata. Sono inoltre integrati 4 faretto LED con cromoterapia e programmazione automatica. Sensory shower può essere abbinata a qualsiasi generatore di vapore Effe ed è disponibile in 3 finiture.

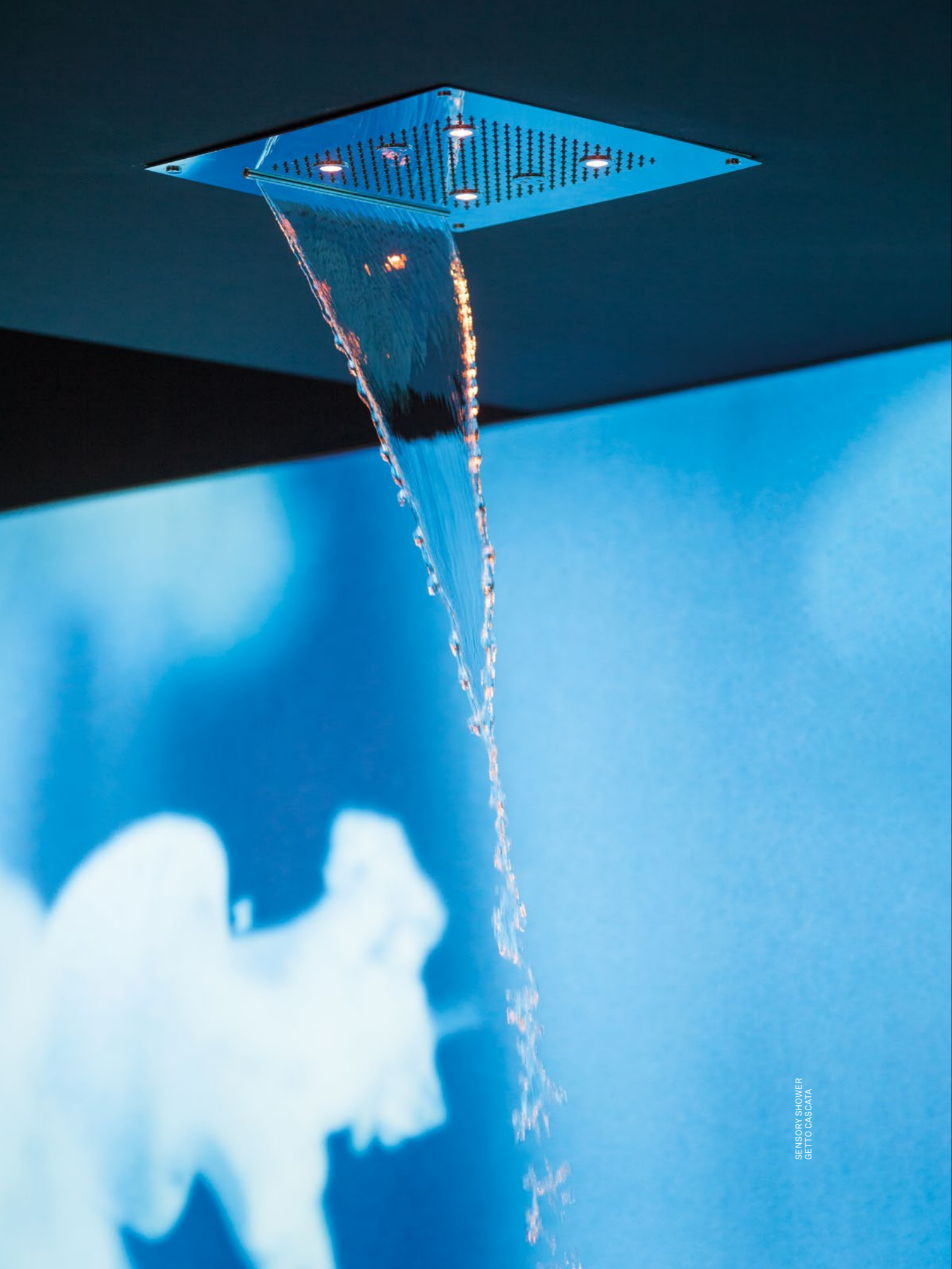

SENSORY SHOWER
GETTO CASCATA

PANNELLO DI CONTROLLO
ACCIAIO INOX SUPER MIRROR

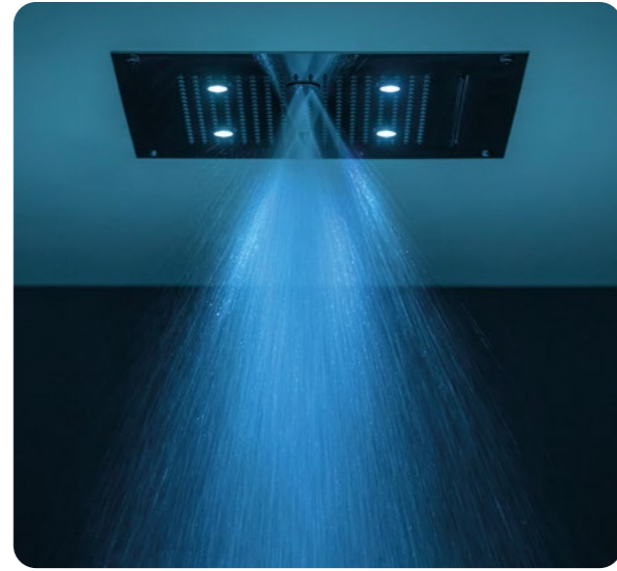

Porte e vetrate

Le speciali porte Effe per hammam sono progettate per ottenere una tenuta perfetta alla fuoriuscita del vapore, garantendo il giusto ricircolo d'aria. L'acciaio inox, l'alluminio e il vetro temperato di 8 mm di spessore rendono ogni modello molto durevole e facilmente abbinabile allo stile di ogni arredamento. Grazie alle porte Effe, anche la semplice doccia di casa può essere trasformata in un perfetto bagno turco.

ADAPTA



70
L 70 CM
H 200 CM



120
L 120 CM
H 200 CM

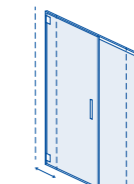

SU MISURA
±20 CM IN LARGHEZZA

SPAZIOSLIDE

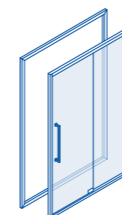

130
L 130 CM
H 200 CM

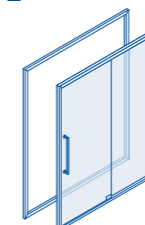

160
L 160 CM
H 200 CM

SPAZIOFILO



80
L 80 CM
H 198 CM



100
L 100 CM
H 198 CM



120
L 120 CM
H 198 CM



160
L 160 CM
H 198 CM

SPAZIO



80
L 80 CM
H 200 CM

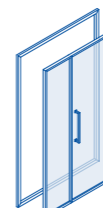

100
L 100 CM
H 200 CM

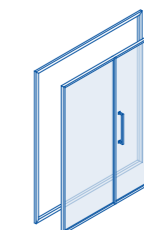

160
L 160 CM
H 200 CM

TUTTOVETRO INSIDE E CONTOUR



MOD. A
INSIDE/CONTOUR
SU-MISURA

INSIDE 70
L 70 CM
H 210 CM



MOD. B
INSIDE/CONTOUR
SU-MISURA

INSIDE 120
L 120 CM
H 210 CM



MOD. C
INSIDE/CONTOUR
SU-MISURA

INSIDE 170
L 170 CM
H 210 CM

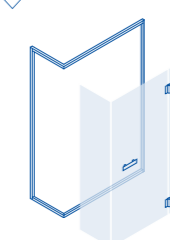

MOD. D
INSIDE/CONTOUR
SU-MISURA

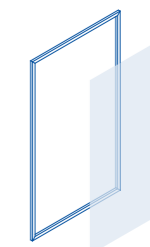

MOD. E
INSIDE/CONTOUR
SU-MISURA

Adapta: la porta resa semplice

Adapta è la nuova porta Effe per hammam che si può montare sul pavimento finito, senza bisogno di controtelaio. Le regolazioni permettono inoltre di adattarsi a superfici non perfettamente a quadro: facile e veloce.



ADAPTA
PROFILI INOX
FINITURA PVD: NERO SATINATO



SISTEMA DI REGOLAZIONE

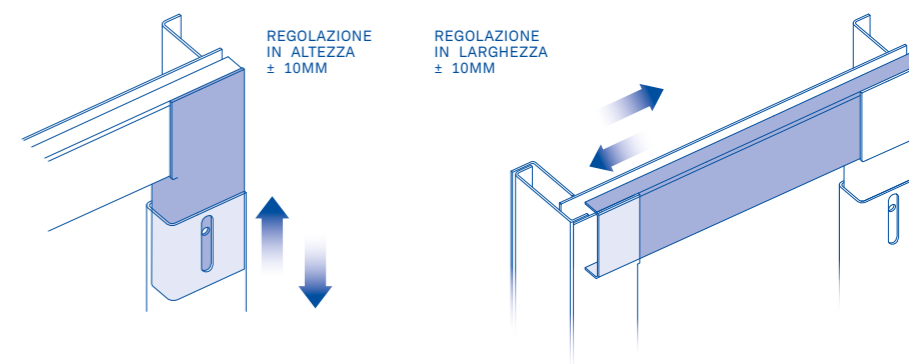

DETTAGLIO DELLA
VERSIONE CON/SENZA
PROFILO A TERRA

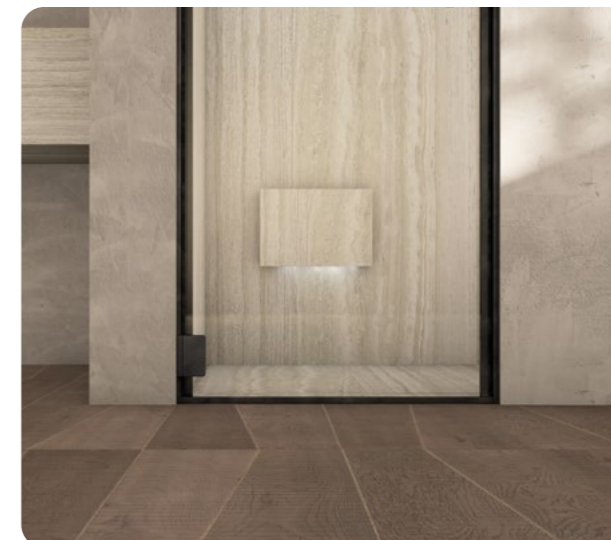
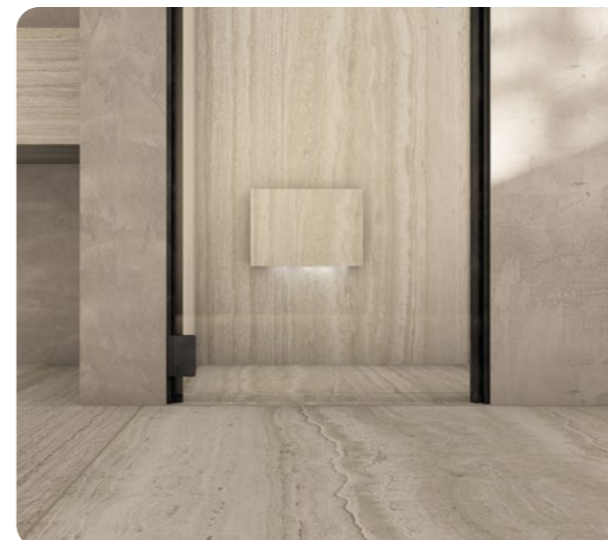

SPAZIOSLIDE



SPAZIOFILO



SPAZIO



TUTTOVETRO
INSIDE



TUTTOVETRO
CONTOUR



TUTTOVETRO INSIDE

INSIDE È CARATTERIZZATA DA UN PROFILO
COMPLETAMENTE INCASSATO, UNA SOLUZIONE
ESTREMAMENTE ESSENZIALE E RAFFINATA

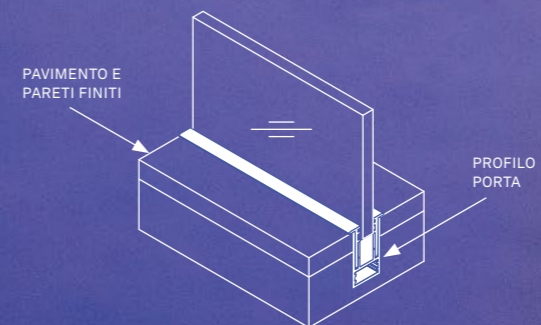

TUTTOVETRO CONTOUR

CONTOUR PERMETTE LO STESSO GRADO DI
FLESSIBILITÀ INTEGRANDO UN PROFILO
DI SOLI 25 MM

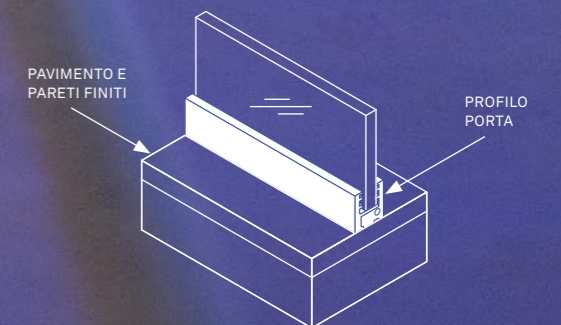



Sedute

Serie di arredi progettati in maniera specifica per l'interno dell'hammam e della doccia, con materiali facili da pulire e resistenti all'azione dell'acqua.

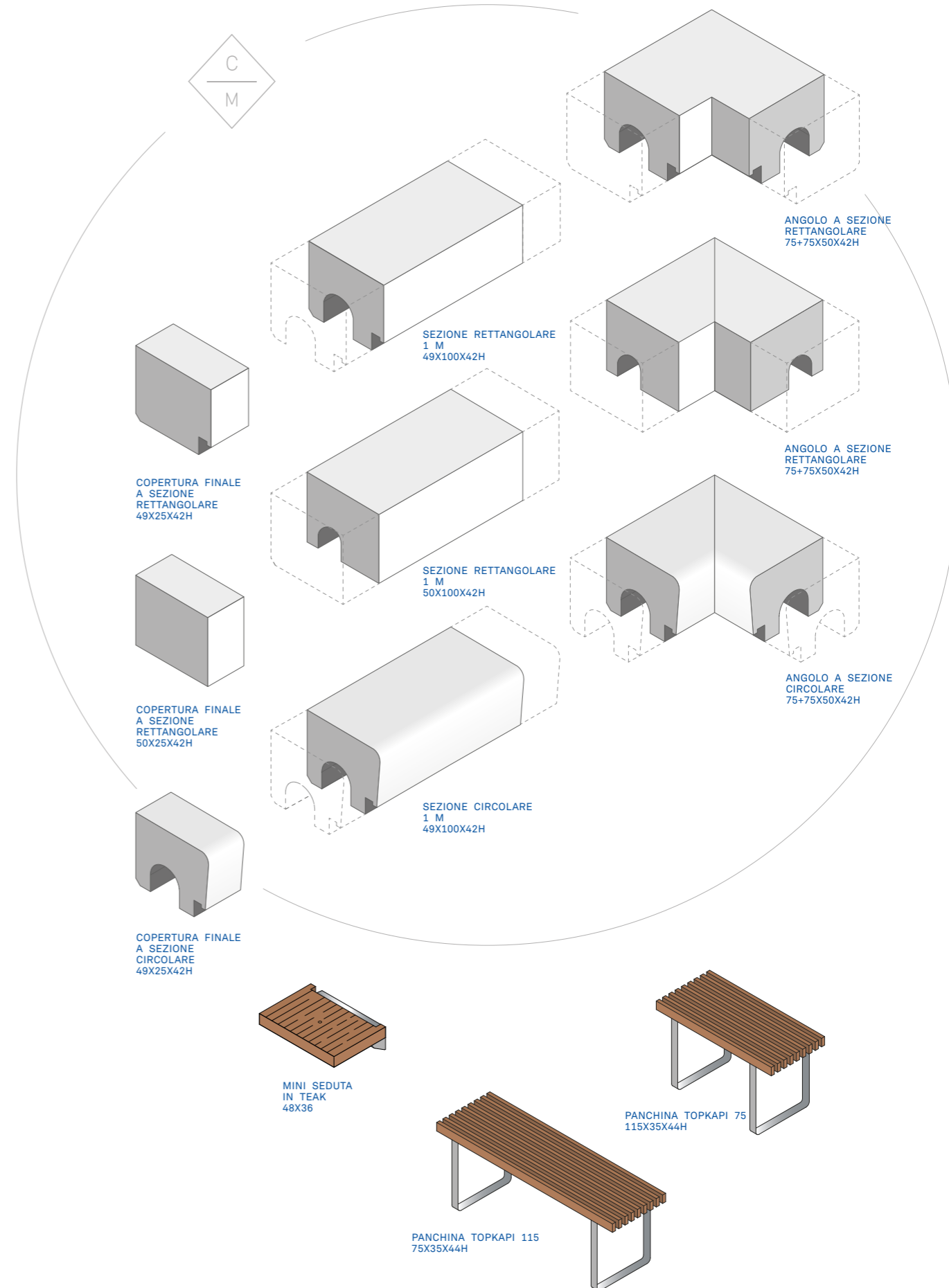



PANCHINA TOPKAPI 115
IN TEAK NATURALE



PANCHINA TOPKAPI 75
IN TEAK NATURALE



MINI SEDUTA
IN TEAK

Arredi e accessori

Effe ha studiato complementi d'arredo come poltrone, lettini, tavoli e chaise longue, che si abbinano a saune e hammam per completare con stile la vostra area benessere.





BODYLOVE RELAX LOUNGER
IN HEMLOCK CANADESE
CON GAMBE IN METALLO VERNICIATO



BODYLOVE RELAX LOUNGER
HEMLOCK CANADESE



BODYLOVE RELAX LOUNGER:
LEGNO MASSICCIO TERMO-TRATTATO.
TAVOLO: STRUTTURA IN ALLUMINIO VERNICIATO
PIANO IN GRES PORCELLANATO BIANCO



RADISSON COLLECTION HOTEL
PALAZZO TOURING CLUB MILANO, ITALIA
PH. ANDREA MARTIRADONNA

SECCHIO DA DOCCIA
OTIUM RELAX LOUNGER

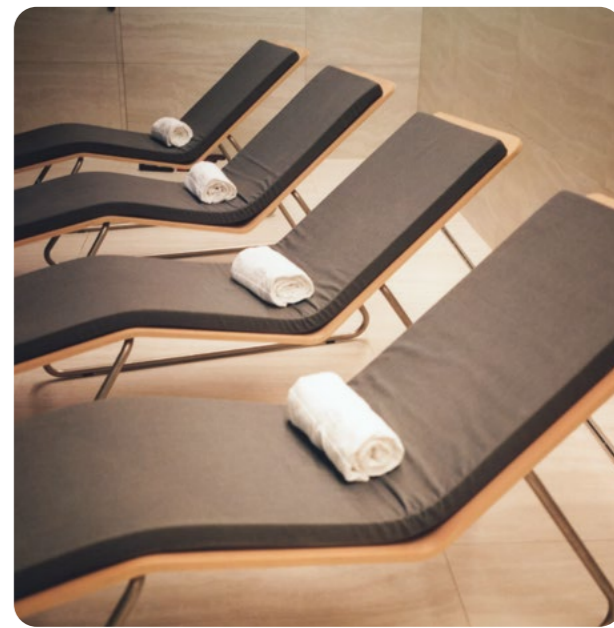

TUBO DOCCIA
KNEIPP

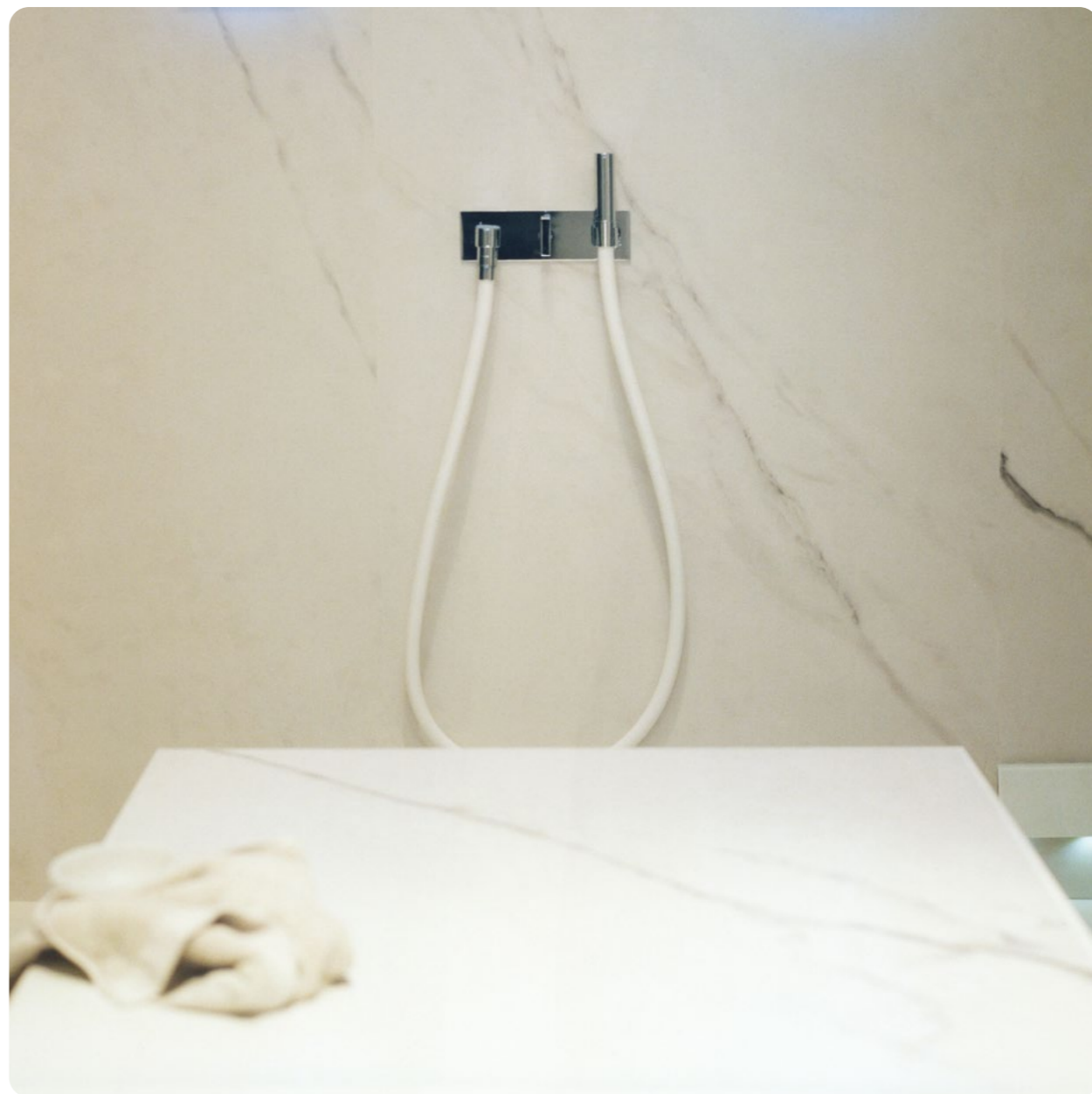

Fragranze biologiche per saune e hammam ispirate alle energie della natura.

Remedia ha creato una gamma esclusiva di fragranze per sauna e Hammam per Effe che esaltano i benefici di questi antichi rituali grazie al loro effetto olfattivo e quasi onirico. Remedia utilizza prodotti naturali biologici, coltivati e lavorati secondo le antiche tradizioni dell'erboristeria alchemica.



Acqua.

Fluidità,
Equilibrio,
Armonia.

Nella gioia si esprime il sorriso di Arancio dolce che culla il piacere di vivere. Le note profumate ritmano il canto dell'acqua, semplice e puro come Lavanda, pulito e cristallino come Eucalipto.

Acqua ci coccola, si prende cura di noi, ci avvicina alle emozioni più incantate, lascia spazio al bambino interiore. Ci accompagna a trovare serenità ed armonia. Il rituale diventa un momento di pace profonda.

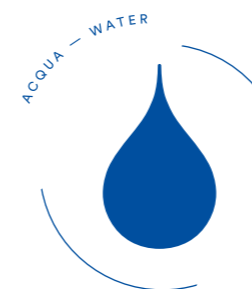

Fuoco.

Passione,
Forza vitale,
Sistema
immunitario.

Note agrumate danno spazio e ardore al caldo Cardamomo attorno al quale danza l'intrepido Ginepro dalle note suadenti e fortificanti. Nulla può resistere all'ingresso di Cannella dolce, calda e curativa come il sole.

Fuoco è energia, pura vita celebrata nell'ardore e nella forza. Tutto il corpo si riallinea e si appassiona. Il rituale ci ricarica e stimola la nostra forza vitale agendo sul sistema immunitario.



Terra.

Radicalamento,
Corpo fisico,
Centratura,
Presenza.

Note intense e profonde di Vetiver e Cedro avvolgono il corpo e celebrano la sua sacralità. Il suadente Patchouli acquieta la mente e dona sensualità accompagnato alla dolcezza da Benzoino e Coriandolo.

Terra ci accompagna alla sacralità del Corpo e esalta il rituale della Sauna o del Bagno Turco quando ci siamo dimenticati della nostra presenza fisica. Aiuta a riconnetterci con le esigenze del corpo e dei suoi veritieri messaggi.



Aria.

Pensiero,
Spaziosità,
Respiro,
Leggerezza.

Il suono di Litsea arriva da lontano e si annuncia fresco e rigenerante come il vento che spazza nubi nere. Il balsamico Alloro ne amplia il respiro e riconduce la mente alla purezza sul tintinnio della Menta.

Aria purifica la mente sovraccarica, la libera, la alleggerisce. Dilegua il peso del mentale e sostiene il respiro. Il rituale ci rigenera e ci apre a nuovi vedute.

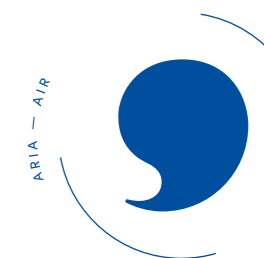

LE MIGLIORI TECNOLOGIE HAMMAM



NUVOLA SMART
TOUCH&STEAM SMART
EASYSTEAM SMART
INSIDE

	PSF Power Steam Function L'innovativo sistema di gestione della ventilazione minimizza la stratificazione delle temperature all'interno della cabina.	■	■	■	■
	SEC Smart Energy Control Distribuzione uniforme nel tempo dei cicli di accensione e spegnimento delle termoresistenze in modo da ottenere una diffusione costante del vapore.	■	■	■	■
	SBC Smart Boiler Cleaning Diluizioni e risciacqui intermedi calcolati sul reale fabbisogno per ridurre l'accumulo di calcare e aumentare la durata della caldaia senza manutenzione.	■	■	■	■
	SWF Smart Water Flow Gestione ottimizzata di riempimento caldaia, risciacqui intermedi e svuotamento. Le resistenze lavorano sempre in maniera ottimale.	■	■	■	■
	RWF Regulating Water Flow Il generatore può lavorare dentro un ampio range di pressione dell'impianto idrico del locale: da 0,2 bar a 10 bar.	■	■	■	■
	ECC Effe Comfort Control Il sistema è integrato nel generatore di vapore Effe e consente di gestire a distanza il bagno turco tramite l'app My Effe.	■	■	■	
	ODS Open Door Sensor Il sistema è in grado di bloccare automaticamente l'erogazione del vapore in caso di prolungata apertura della porta del vano hammam.	■	■	■	■
	ESS Effe Sound System Dispositivo Bluetooth per l'ascolto di musica all'interno della sauna o dell'hammam.		■		

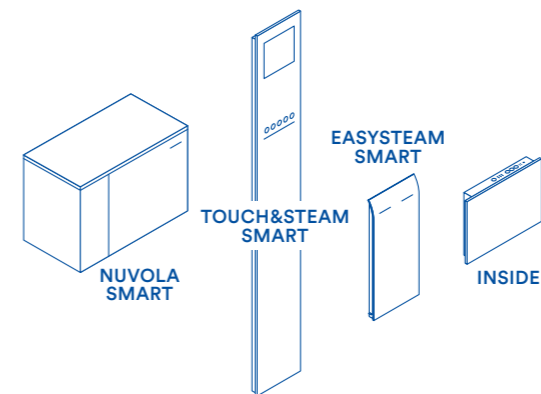

NUVOLA SMART
TOUCH&STEAM SMART
EASYSTEAM SMART
INSIDE

Diffusori dotati di alette per direzionare il flusso di vapore.	■	■	■
Sonda di temperatura addizionale.	■		
Pannello di controllo touch con icone retroilluminate e misuratore di temperatura.	■	■	■
Contenitore di oli essenziali per aromaterapia.	■	■	■
Luce LED nel punto di uscita del vapore.	■	■	■
Sistema di illuminazione con LED RGB e cromoterapia.		■	■
Superficie dell'erogatore personalizzabile.	■		■

CATALOGUES IN ENGLISH
 CATALOGHI IN ITALIANO
 KATALOGE IN DEUTSCHER SPRACHE
 CATALOGUES EN FRANÇAIS
 CÁTALOGOS EN ESPAÑOL
 КАТАЛОГИ НА РУССКОМ ЯЗЫКЕ
 目錄



L.P.EFFE.IT/
 CATALOGUES

EFFE®: TUTTI I DIRITTI RISERVATI.
 LA RIPRODUZIONE TOTALE O PARZIALE
 DEL TESTO O DELLE IMMAGINI DI QUESTO
 CATALOGO È VIETATA E SOGGETTA A
 SANZIONI LEGALI.

LE IMMAGINI E I DATI CONTENUTI IN
 QUESTO CATALOGO SONO PURAMENTE
 INDICATIVI E POSSONO ESSERE
 MODIFICATI IN QUALSIASI MOMENTO
 SENZA PREAVVISO.

DIREZIONE ARTISTICA E GRAPHIC
 DESIGN: ZUP DESIGN.
 FOTOGRAFIA: SIMONE CASSETTA
 (SE NON DIVERSAMENTE SPECIFICATO).

CERTIFICAZIONI INTERNAZIONALI



KTW



I generatori di vapore Effe sono progettati
 e costruiti in conformità con i principali
 enti di certificazione mondiali.



PROGETTO SPA

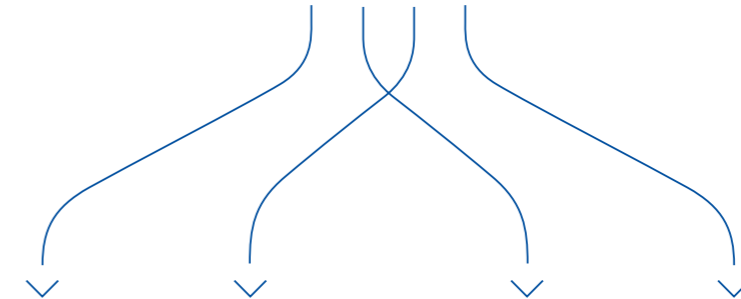

TEAM DI SVILUPPO EFFE



ARCHITETTURA



INGEGNERIA



PRODUZIONE



COORDINAZIONE

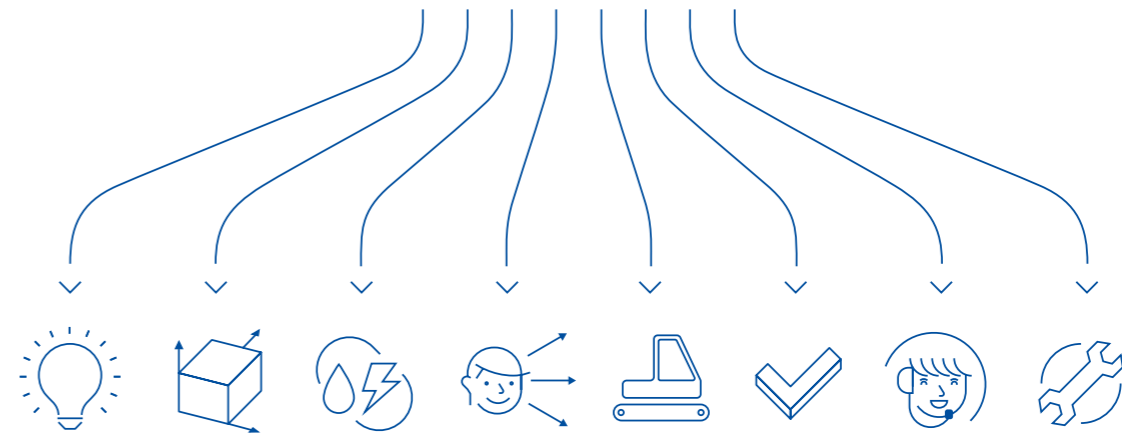

FASE INIZIALE DI
 IMPOSTAZIONE
 CREATIVA DELLO
 SPAZIO BENESSERE

FASE DI
 PROGETTAZIONE
 DETTAGLIATA
 DEL LAYOUT

PROGETTAZIONE
 ESECUTIVA E
 DEFINIZIONE
 DEGLI IMPIANTI

INTERFACCIA
 CONTINUA CON GLI
 ALTRI INTERLOCUTORI
 DI PROGETTO

SUPPORTO
 IN CANTIERE
 TRAMITE
 SOPRALLUOGHI

MONTAGGIO
 E COLLAUDO
 FINALE

SERVIZI
 POST-VENDITA
 PERSONALIZZATI

ASSISTENZA
 TECNICA E
 MANUTENZIONE
 A LUNGO TERMINE

Effe è il partner ideale per la progettazione e la costruzione
 di aree dedicate al benessere, pubbliche o private, grazie
 ad un team di professionisti che ti affianca in ogni fase.
 Un know how impareggiabile che garantisce qualità, la cura
 dei dettagli e innovazione tecnologica.



CABANON GARDEN
FINITURA MUSCHIO - DECK LARGE



effe

PERFECT WELLNESS



Effe
Cesena (FC)
Italy
www.effe.it